

Sachtler Ace Accessories – professional gear for Pro-Videographers

ace



► Accessories

Ace Base Plate

Sachtler's sturdy platform for proper filmmaking

 Payload: 6 kg / 13.2 lbs

 Height range:
48 mm / 1.9 in (fully retracted)
72 mm / 2.8 in (fully extended)

 Weight: 0.6 kg / 1.3 lbs

MEASUREMENTS IN MM

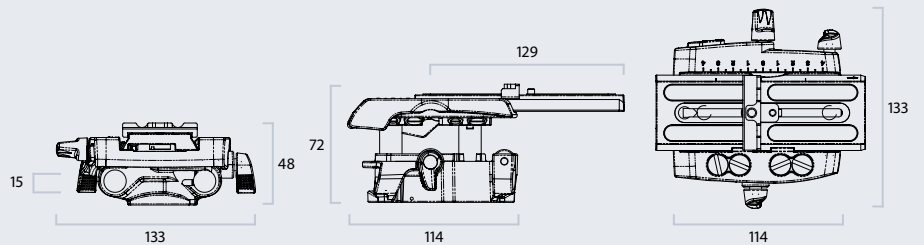

ace

ORDERCODE

► S2154-0001



Two 15 mm support rods can be attached to the Ace Base Plate to be fitted and adjusted as required.



IDEAL ACCESSORY FOR 75 MM FLUID HEADS

System Ace L MS CF	► 1011	FSB 8	► 0707
System Ace L GS CF	► 1012	FSB 8T	► 0705
System Ace L TT 75/2 CF	► 1013	FSB 6	► 0407
System Ace M MS	► 1001	FSB 6T	► 0405
System Ace M GS	► 1002	FSB 4	► 0307

Accessories shown with Sachtler products may be optional.

Sachtler in association with its sister brands, provides complete pro-video solutions with best-in-class, innovative products around the camera.

**ANTON
BAUER**

 **Litepanels**

PETROL
B A G S

► Accessories

Ace Matte Box

Professional shooting and filtering for preventing glare and lens flare

 Payload: 1 kg / 2.2 lbs (each side)

 Weight: 0.9 kg / 2 lbs

 Max diameter lens: 143 mm / 5.5 in

FILTER FRAMES

 Square filters: 4 × 4 in
Rectangular filters: 4 × 5.65 in

ROD BRIDGE

 Support rod diameter: 15 mm / 0.5 in

 Height rod bridge small:
85 mm / 3.3 in (Small diameter camera lens configuration—centre of support rod to centre of rear clamping interface)

Height rod bridge large:
109 mm / 4.3 in (Large diameter camera lens configuration—centre of support rod to centre of rear clamping interface)

MEASUREMENTS IN MM

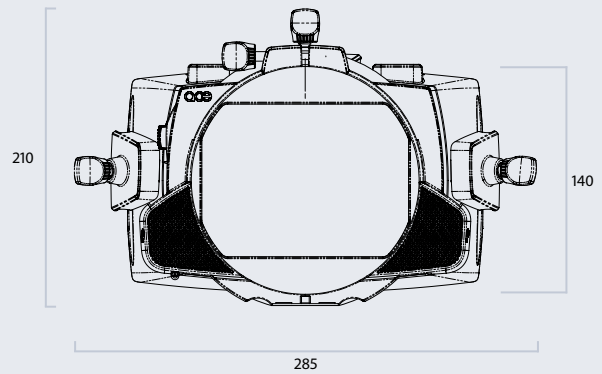

ace

ORDERCODE

► S2152-0001



Two accessory bars allow a variety of products to be attached to the sunshade.



IDEAL ACCESSORY FOR 75 MM FLUID HEADS

System Ace L MS CF	► 1011	FSB 8	► 0707
System Ace L GS CF	► 1012	FSB 8T	► 0705
System Ace L TT 75/2 CF	► 1013	FSB 6	► 0407
System Ace M MS	► 1001	FSB 6T	► 0405
System Ace M GS	► 1002	FSB 4	► 0307

Accessories shown with Sachtler products may be optional.

Sachtler in association with its sister brands, provides complete pro-video solutions with best-in-class, innovative products around the camera.

ANTON BAUER



 Litepanels

PETROL
B A G S

▶ Accessories

Ace Follow Focus

Sachtler's compulsory piece of equipment for more efficient and precise shots

-  Weight: 0.45 kg / 1 lbs
-  Diameter Lens: 39 to 128 mm / 1.5 to 5.0 in
- Diameter rods: 15 mm / 0.5 in

DRIVE GEAR

-  Diameter friction wheel: 35 mm / 1.4 in
- 50 tooth / Mod 0.8

MEASUREMENTS IN MM

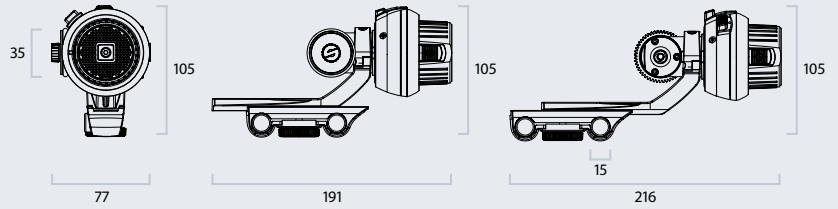

ace

ORDER CODE

▶ S2153-0001



The Ace Follow Focus comes with two marking discs that can easily be mounted to the hand wheel.



IDEAL ACCESSORY FOR 75 MM FLUID HEADS

- | | | | |
|-------------------------|--------|--------|--------|
| System Ace L MS CF | ▶ 1011 | FSB 8 | ▶ 0707 |
| System Ace L GS CF | ▶ 1012 | FSB 8T | ▶ 0705 |
| System Ace L TT 75/2 CF | ▶ 1013 | FSB 6 | ▶ 0407 |
| System Ace M MS | ▶ 1001 | FSB 6T | ▶ 0405 |
| System Ace M GS | ▶ 1002 | FSB 4 | ▶ 0307 |

Accessories shown with Sachtler products may be optional.

Sachtler in association with its sister brands, provides complete pro-video solutions with best-in-class, innovative products around the camera.

