

HPRC[®]
HIGH PERFORMANCE RESIN CASES



2014/15
CASES
WORKBOOK

H P R C C A S E S
MADE IN ITALY
M A N U F A C T U R E D



Our Brand

We're about happiness by cases. It means we're not just in the business of creating protective cases, even though that is what we do. Our everyday commitment is designed to make people happy.

From an ever-growing collection of innovative products to our passionate team who makes it happen, it's all about happiness.

Our Products

We're always looking for what's next. We're constantly innovating our original designed form and function, proving a fresh approach to the art of cases. By incorporating different styles, top quality materials and eye-catching patterns into our design, we make more than a case. We make a statement.

Our History

HPRC cases were born in 2006 with one simple premise: we can design a better case. In almost 10 years HPRC has grown into a successful international business, teaming up with important companies and partners. Our products can be found in 76 countries and have garnered top awards and praise. As we grow, our entrepreneurial spirit continues to drive the HPRC culture. After all, it's what helped us build one of the world's best hard cases brand.

Ultralight. Watertight. Smart Cases.

HPRC cases can be used for all sorts of applications and different areas: photography, industrial, military, nautical, police and many others. HPRC provides total protection to the carried equipment against dust, water, impacts and corrosion for chemical agents.



Outdoor | Diving | Marine



Photo | Video



Industrial | Electronic | It



Photo by Luigi Fienti

Military | Government



Photo by Flavio Oliva

Fire | Emergency | Medical

Highlights

2014/2015

HPRC X4 - 2760W



HPRC achieves a new dimension in the highly protective resin cases market presenting **HPRC2760W**, the only case on the market featuring 4 built in wheels and 3 functional and comfortable handles.

One case, 3 uses: case, cart and trolley, depending on how you need to carry it. Using one of the two side handles and pushing or pulling the case as a trolley. Or as a case, using the comfortable, soft grip handle. You can use both lateral handles when you need two people to move it. Or you can also use it as a cart, by stacking the cases

on top of each other to easily push or pull them while they're on the ground. Braked wheels allow to block the case preventing unexpected movement and guaranteeing therefore maximum safety. Discover all the features of this new innovative case, on the dedicated mini website: <http://www.hprcx4.it/>

More info at page: 32



HPRC[®] *X4*
HIGH PERFORMANCE RESIN CASES

HPRC4200



The new **HPRC4200** is the latest HPRC shoulder case. It is excellent especially for carrying LED lights and stands, but it also works very well for all audio, video, and photo equipment. The new Roll Body System (RBS) lets the strap follow the natural

body movement while walking, running or hiking. Its size allows to carry it as hand luggage on airplanes. It is available in black, with foam, soft deck (divider kit) system, or interior bag. **More info at page: 40**

HPRC6200

The **HPRC6200** is the smallest case of the 6000 series. It's designed to easily carry compact tripods, thanks to the large central handle, and the smaller soft-grip side one. The case opens on the long side for an easy access to its contents, and it is secured by a double-hinged latch system. It is meant to hold and transport your audio, video and photo gear safely.

More info at page: 46



HPRC4700W

This new model by HPRC is unique in its kind, especially for two special features: the telescopic aluminum trolley handle, and the XXL wheels. These wheels, which are bigger than the traditional ones, allow you to carry the case on any

surface. The wheels are made internally of polypropylene and of thermoplastic rubber -TPV type - in the outer part. **More info at page: 44**



Committments

Our committment to you:

1.UNDERSTAND the problems of your market and your specific requirements. Through our expert knowledge of technological and economic trends we can offer an uncompromisingly individual approach to each customer.

2.FIND a transport solution tailored to your requirements. Our extensive cases range, our custom solutions that go far beyond our product offer, our team that assists you in selecting the case that is best suited to your own needs, are our core strengths.

3.LISTEN to and take account of your comments, through our network of experts and our frequent satisfaction surveys.

4.BE incessantly innovative and competitive in the professional cases market.

HPRC: innovation, technology and design.

Most of hard watertight cases are made in standard pp: our r&d department has developed an enhanced compound, still based on pp, now balanced with additional high performance resins. Ttx01® allows to produce cases which are lighter in weight and stronger in robustness. The special mix we added makes the HPRC shell thinner and more elastic, increasing therefore the shockproof degree and the lightweight. On the top of that, maintaining pp characteristics, HPRC cases are acidproof, scratchproof, able to resist to extreme weather conditions and temperature changes (all products are tested from - 40° c up to 80°c).



pole: ALU



body: TTX01® hardware: steel



wheels: PA66+PUR



handle: PP+SEBS



latches: POM



ext.handle: PA66GF30

Do you want to know more?
Please contact our technical team: tech@hprc.it



HPRC life time warranty: HPRC products have been built to rigorous standards of quality and are guaranteed against all defects in materials and workmanship for the whole life of the case.



Airex is the new automatic purge valve that is auto press release adjusted to changing environments automatically.

The attention and respect toward the environment and the commitment to an eco-sustainable future are important values for HPRC

 we case in **green.**

Our commitment starts from the design phase of the product, and involves all the production stages including the management of the impact of the product's end of life. All shells and components of HPRC cases are 100% recyclable: the production and transformation discards are infact reintegrated in the production cycle. The high resistance of the patented material ttx01® allows to use the HPRC cases longer than any other case, reducing therefore the emissions of CO2 due to the production

and distribution. The constant quest for suppliers complying with iso 14000 or emas certification and which are geographically close to our company is a contribute to reduce the environmental impact and represents a challenge in a world where firms usually aim only for low price suppliers not considering their possibly higher environmental impact. Moreover HPRC adopts renewable sources plants for energy production to cover the energetic needs.

Standard cases

HPRC cases are available with a standard setup if you don't need any special customization regarding the shell or the interior foam. Here are the 4 possible standard configurations.

* EMPTY - USA: E



* CUBED FOAM - USA: F



* INTERIOR BAG - USA: IC



* SOFT PADDED OPEN DECK + DIVIDERS - USA: DK



*** PANEL FRAME MOUNTING SYSTEM AVAILABLE**

Oem cases

We are cases producers,
if you do not find the right size or best liked design
we will make a customized case for you

1. Product inquiry >>>> Mold + price offer
2. Contract signing >>>> Design drawing
3. Client confirmation >>>> Mold making
4. Sample checking >>>> Production arrangement



Custom fit cases

Customization concerns: color, printing, adhesive, foam inlay (die cut, water cut, milled, moulded), thermoformed inlay, lid panels and organizer, extra working on the cases shell (holes, external applications) keeping the water tightness.



HIGH VISIBILITY INLAYS

A special high visibility inlay can be designed in order to avoid forgetting equipment on the field after use.



CUSTOMIZED LAYOUT

We give customers different equipment layouts options in order to optimize space and handiness.



CUSTOMIZED COVERS

Customization also includes the possibility to design solutions in order to use the cover as a glove compartment. We can provide organizers, special tools addition, shell modifications and custom colors.



SHELL CUSTOMIZATION

HPRC customization service also provides shell customization, including holes for external connections.

HPRC panel frame accessory (HPRCPF) allows customers to install a control panel into the case, ensuring a perfect fit.



INJECTION INLAYS

The custom inlay made in expanded polypropylene of different densities guarantees a perfect protection and a professional look to the case. Our service includes the initial study of the mould and goes through the prototype phase and final production.



MILLED FOAMS

The milling technology allows to get one piece inlays with many different depths.

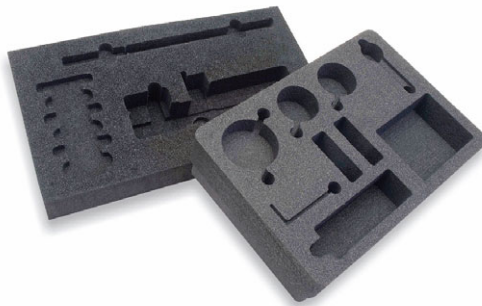

WATER CUTTING TECHNOLOGY FOAMS

Expanded polyethylene foams are available in various densities (Kg/m³), resistance to compression (kPal) and resistance to different temperatures ranges (°C). These foams, produced with water cutting technology, guarantee a good protection and allow a wide range of customizations.

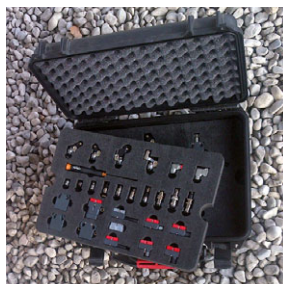

MULTY LAYER

A multi layer case is a handy solution, especially when equipment is made of many small and different parts that must be stored and protected into one case only.

HPRC 1100



* open cases images reflect the different HPRC cases internal options

TECHNICAL FEATURES

Dimension:

internal dimension 57x58x25,5(mm) - 2,24x2,28x1,00(in)
external dimension 69x80x32(mm) - 2,72x3,15x1,26(in)

lid: 12,8(mm) - 0,50(in) bottom: 12,7(mm) - 0,50(in)

Weight:

empty: 0,04kg - 0,09lbs

available empty or with memory card storage

Temperature rating:

Minimum Maximum
-40°C -40°F +80°C +176°F

Colors:

Black - Ferrari red



TECHNICAL DRAWING

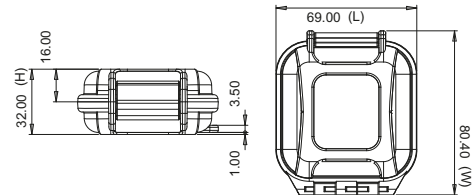

<p>* memory card case</p>	<p>* empty case</p>		<p>APPROVALS ATA 300 IP67 STANAG 4280 DS 81-41</p> <p>TEST DROP IMPACT HANDLE WATERTIGHT INTEGRITY UV COLOR AND MATERIAL PROTECTION</p> <p>lt volume in litres wheeled</p>

FEATURES

- Removable multiformat memory card holder
- Accepted card Formats: SD, Memory stick, Memory stick pro duo, Mini SD
- Holds up to 2 memory cards per format
- Full/empty indicator

* open cases images reflect the different HPRC cases internal options



TECHNICAL FEATURES

Dimension:

internal dimension 116x67x25,5(mm) - 4,57x2,64x1,00(in)
external dimension 127x90x32(mm) - 5,00x3,54x1,26(in)

lid: 12,8(mm) - 0,50(in) bottom: 12,7(mm) - 0,50(in)

Weight:

empty: 0,09kg - 0,19lbs

available empty or with memory card storage

Temperature rating:

Minimum Maximum
-40°C -40°F +80°C +176°F

Colors:

Black - Ferrari red



TECHNICAL DRAWING

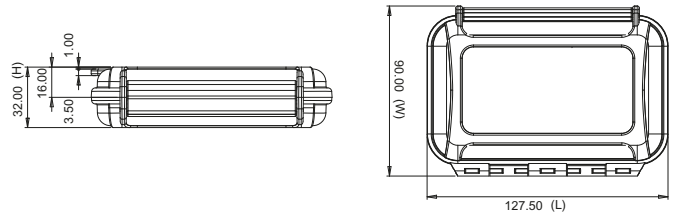

* cubed foam



* memory card case



* memory Card Case for video



APPROVALS
ATA 300
IP67
STANAG 4280
DS 81-41

TEST
DROP
IMPACT
HANDLE
WATERTIGHT INTEGRITY
UV COLOR AND MATERIAL
PROTECTION



FEATURES

- Removable multiformat memory card holder
- Accepted card Formats: SD, Memory stick, Memory stick pro duo, Mini SD
- Holds up to 2 memory cards per format
- Full/empty indicator



HPRC 2100



* open cases images reflect the different HPRC cases internal options

TECHNICAL FEATURES

Dimension:

internal dimension 210x145x94(mm) - 8,27x5,71x3,70(in)
external dimension 235x196x110(mm) - 9,25x7,72x4,33(in)



lid: 18(mm) - 0,71(in) bottom: 76(mm) - 2,99(in)

Weight:

empty: 0,76kg - 1,68lbs
with cubed foam: 0,84kg - 1,85lbs

Temperature rating:

Minimum Maximum
-40°C -40°F +80°C +176°F

Colors:

Black - Orange - Ferrari red - Electric blue

TECHNICAL DRAWING

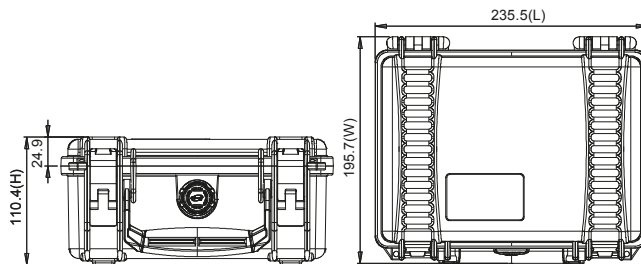

* cubed foam



* interior bag



APPROVALS
ATA 300
IP67
STANAG 4280
DS 81-41

TEST
DROP
IMPACT
HANDLE
WATERTIGHT INTEGRITY
UV COLOR AND MATERIAL
PROTECTION



ACCESSORIES

HPRCCF2100
CUBED FOAM
USA:HPRCFO (foam only)

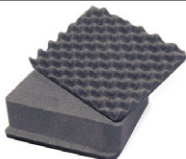

HPRCLO
PADLOCK - TSA



HPRCCB2100
INTERIOR BAG
USA:HPRCIC (internal case)



HPRCPANELFRAME
(panel not included)



* open cases images reflect the different HPRC cases internal options



TECHNICAL FEATURES

Dimension:

internal dimension 236x182x108(mm) - 9,29x7,17x4,25(in)
external dimension 258x230x123(mm) - 10,16x9,06x4,84(in)



lid: 29(mm) - 1,14(in) bottom: 79(mm) - 3,11(in)

Weight:

empty: 0,87kg - 1,92lbs
with cubed foam: 1,08kg - 2,38lbs

Temperature rating:

Minimum -40°C -40°F Maximum +80°C +176°F

Colors:

Black

TECHNICAL DRAWING

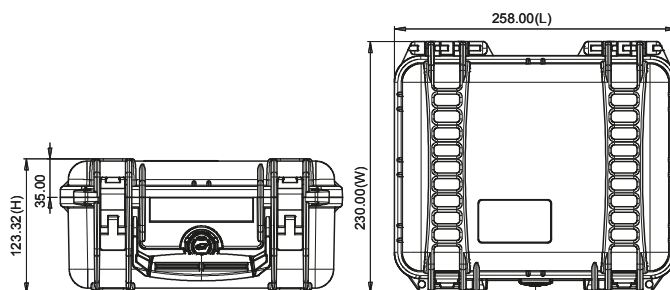

* cubed foam



* interior bag



APPROVALS
ATA 300
IP67
STANAG 4280
DS 81-41

TEST
DROP
IMPACT
HANDLE
WATERTIGHT INTEGRITY
UV COLOR AND MATERIAL
PROTECTION



ACCESSORIES

HPRCCF2200
CUBED FOAM
USA:HPRCFO (foam only)

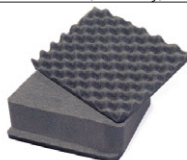

HPRCLO
PADLOCK - TSA



HPRCCB2200
INTERIOR BAG
USA:HPRCIC (internal case)



HPRCPANELFRAME
(panel not included)



HPRC 2250



TECHNICAL FEATURES

Dimension:

internal dimension 236x182x155(mm) - 9,29x7,17x6,10(in)
external dimension 258x230x170(mm) - 10,16x9,06x6,69(in)



lid: 29(mm) - 1,14(in) bottom: 126(mm) - 4,96(in)

Weight:

empty: 1,00kg - 2,20lbs
with cubed foam: 1,35kg - 2,97lbs

Temperature rating:

Minimum Maximum
-40°C -40°F +80°C +176°F

Colors:

Black

TECHNICAL DRAWING

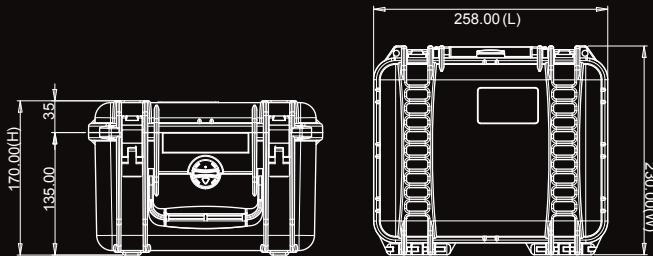

* cubed foam



* interior bag



APPROVALS
ATA 300
IP67
STANAG 4280
DS 81-41

TEST
DROP
IMPACT
HANDLE
WATERTIGHT INTEGRITY
UV COLOR AND MATERIAL
PROTECTION



ACCESSORIES

HPRCCF2250
CUBED FOAM
USA:HPRCFO (foam only)

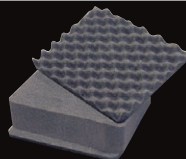

HPRCLO
PADLOCK - TSA



HPRCCB2250
INTERIOR BAG
USA:HPRCIC (internal case)



HPRCPANELFRAME
 (panel not included)



* open cases images reflect the different HPRC cases internal options



TECHNICAL FEATURES

Dimension:

internal dimension 304x231x137(mm) - 11,97x9,09x5,39(in)
external dimension 335x289x155(mm) - 13,19x11,38x6,10(in)



lid: 31(mm) - 1,22(in) bottom: 106(mm) - 4,17(in)

Weight:

empty: 1,67kg - 3,68lbs
with cubed foam: 1,90kg - 4,19lbs

Temperature rating:

Minimum -40°C -40°F Maximum +80°C +176°F

Colors:

Black - Orange - Ferrari red - Electric blue

TECHNICAL DRAWING

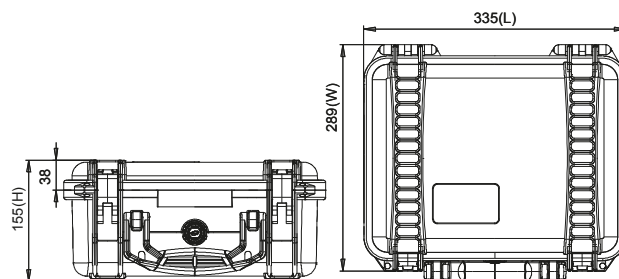

* cubed foam



* interior bag



APPROVALS
ATA 300
IP67
STANAG 4280
DS 81-41

TEST
DROP
IMPACT
HANDLE
WATERTIGHT INTEGRITY
UV COLOR AND MATERIAL
PROTECTION



ACCESSORIES

HPRCCF2300
CUBED FOAM
USA:HPRCFO (foam only)

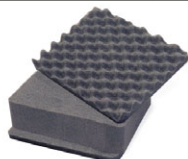

HPRCLO
PADLOCK - TSA



HPRCCB2300
INTERIOR BAG
USA:HPRCIC (internal case)



HPRCPANELFRAME
(panel not included)



HPRC 2400



TECHNICAL FEATURES

Dimension:
 internal dimension 380x266x152(mm) - 14,96x10,47x5,98(in)
 external dimension 405x330x170(mm) - 15,94x12,99x6,69(in)

lid: 45(mm) - 1,77(in) bottom: 107(mm) - 4,21(in)

Weight:
 empty: 2,05kg - 4,52lbs
 with cubed foam: 2,38kg - 5,25lbs

Temperature rating:
 Minimum -40°C -40°F Maximum +80°C +176°F

Colors:
 Black - Orange - Ferrari red - Electric blue



TECHNICAL DRAWING

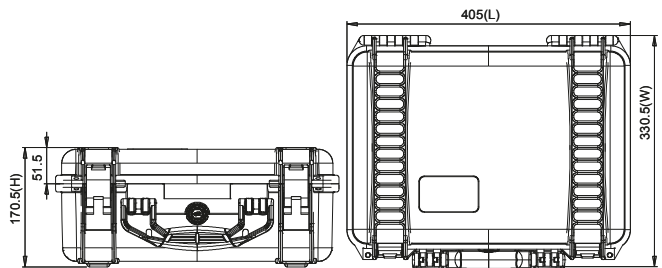

* cubed foam



* interior bag



APPROVALS
 ATA 300
 IP67
 STANAG 4280
 DS 81-41

TEST
 DROP
 IMPACT
 HANDLE
 WATERTIGHT INTEGRITY
 UV COLOR AND MATERIAL
 PROTECTION



ACCESSORIES

HPRCCF2400
 CUBED FOAM
 USA:HPRCFO (foam only)

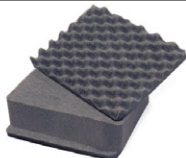

HPRCLO
 PADLOCK - TSA



HPRCCB2400
 INTERIOR BAG
 USA:HPRCIC (internal case)



HPRCORG2400
 LID ORGANIZER



HPRCPANELFRAME
 (panel not included)



* open cases images reflect the different HPRC cases internal options



TECHNICAL FEATURES

Dimension:

internal dimension 409x306x175(mm) - 16,10x12,05x6,89(in)
external dimension 434x371x193(mm) - 17,09x14,61x7,60(in)



lid: 70(mm) - 2,76(in) bottom: 105(mm) - 4,14(in)

Weight:

empty: 2,60kg - 5,73lbs
with cubed foam: 3,14kg - 6,92lbs

Temperature rating:

Minimum -40°C -40°F Maximum +80°C +176°F

Colors:

Black

TECHNICAL DRAWING

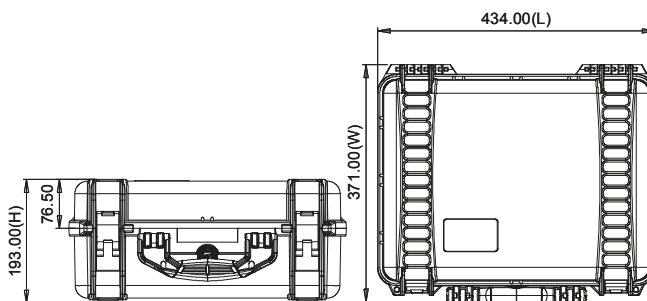

* cubed foam



* interior bag



APPROVALS
ATA 300
IP67
STANAG 4280
DS 81-41

TEST
DROP
IMPACT
HANDLE
WATERTIGHT INTEGRITY
UV COLOR AND MATERIAL
PROTECTION



ACCESSORIES

HPRCCF2460
CUBED FOAM
USA:HPRCFO (foam only)

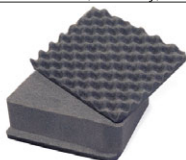

HPRCLO
PADLOCK - TSA



HPRCCB2460
INTERIOR BAG
USA:HPRCIC (internal case)



HPRCORG2460
LID ORGANIZER



HPRCPANELFRAME
(panel not included)



HPRC 2500



TECHNICAL FEATURES

Dimension:
 internal dimension 450x323x175(mm) - 17,72x12,72x6,89(in)
 external dimension 478x390x194(mm) - 18,82x15,35x7,64(in)

lid: 46(mm) - 1,81(in) bottom: 129(mm) - 5,08(in)

Weight:
 empty: 3,15kg - 6,94lbs
 with cubed foam: 3,71kg - 8,18lbs

Temperature rating:
 Minimum -40°C -40°F Maximum +80°C +176°F

Colors:
 Black - Orange - Ferrari red - Electric blue



TECHNICAL DRAWING

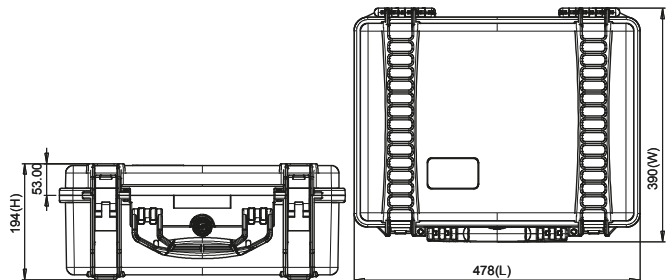

* cubed foam	* interior bag	* soft padded open deck + dividers	APPROVALS ATA 300 IP67 STANAG 4280 DS 81-41	TEST DROP IMPACT HANDLE WATERTIGHT INTEGRITY UV COLOR AND MATERIAL PROTECTION		

ACCESSORIES

HPRCCF2500 CUBED FOAM USA:HPRCFO (foam only)	HPRCLO PADLOCK - TSA	HPRCCB2500 INTERIOR BAG USA:HPRCIC (internal case)	HPRCORG2500 LID ORGANIZER	HPRCPANELFRAME (panel not included)	HPRCSD2500 SOFT PADDED OPEN DECK + DIVIDERS USA: HPRCDK (divider kit)

* open cases images reflect the different HPRC cases internal options

* open cases images reflect the different HPRC cases internal options



TECHNICAL FEATURES

Dimension:

internal dimension 513x288x132(mm) - 20,20x11,34x5,20(in)
external dimension 540x350x135(mm) - 21,26x13,78x5,31(in)



lid: 46(mm) - 1,81(in) bottom: 86(mm) - 3,25(in)

Weight:

empty: 3,20kg - 7,05lbs
with cubed foam: 3,26kg - 7,19lbs

Temperature rating:

Minimum -40°C -40°F Maximum +80°C +176°F

Colors:

Black

TECHNICAL DRAWING

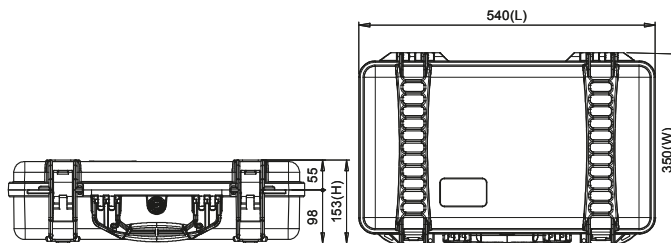

* cubed foam



* soft padded open deck + dividers



APPROVALS
ATA 300
IP67
STANAG 4280
DS 81-41

TEST
DROP
IMPACT
HANDLE
WATERTIGHT INTEGRITY
UV COLOR AND MATERIAL
PROTECTION



ACCESSORIES

HPRCCF2530
CUBED FOAM
USA:HPRCFO (foam only)



HPRCLO
PADLOCK - TSA



HPRCSTRAP



HPRCSD2530 SOFT PADDED
OPEN DECK + DIVIDERS USA:
HPRCDK (divider kit)



HPRC 2550W



TECHNICAL FEATURES

Dimension:

internal dimension 510x285x208(mm) - 20,08x11,22x8,19(in)
external dimension 559x350x233(mm) - 22,01x13,78x9,17(in)

lid: 46(mm) - 1,81(in) bottom: 162(mm) - 6,37(in)

Weight:

empty: 4,85kg - 10,69lbs
with cubed foam: 5,35kg - 11,79lbs

Temperature rating:

Minimum -40°C -40°F Maximum +80°C +176°F

Colors:

Black - Orange - Ferrari red - Electric blue



TECHNICAL DRAWING

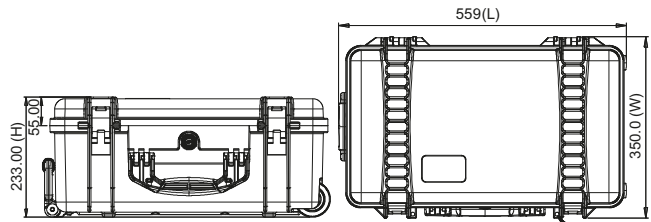

* cubed foam



* interior bag



* soft padded open deck + dividers



APPROVALS
ATA 300
IP67
STANAG 4280
DS 81-41

TEST
DROP
IMPACT
HANDLE
WATERTIGHT INTEGRITY
UV COLOR AND MATERIAL
PROTECTION



ACCESSORIES

HPRCCF2550W
CUBED FOAM
USA:HPRCFO (foam only)



HPRCLO
PADLOCK - TSA



HPRCCB2550W
INTERIOR BAG
USA:HPRCIC (internal case)



HPRCORG2550W
LID ORGANIZER



HPRCSD2550W SOFT PADDED
OPEN DECK + DIVIDERS USA:
HPRCDK (divider kit)



HPRC 2580

* open cases images reflect the different HPRC cases internal options



TECHNICAL FEATURES

Dimension:

internal dimension 390x310x89(mm) - 15,35x12,20x3,50(in)
external dimension 410x359x110(mm) - 16,14x14,13x4,33(in)



lid: 44(mm) - 1,73(in) bottom: 45(mm) - 1,77(in)

Weight:

empty: 2,40kg - 5,29lbs
with cubed foam: 2,57kg - 5,67lbs



Temperature rating:

Minimum -40°C -40°F Maximum +80°C +176°F



Colors:

Black

TECHNICAL DRAWING

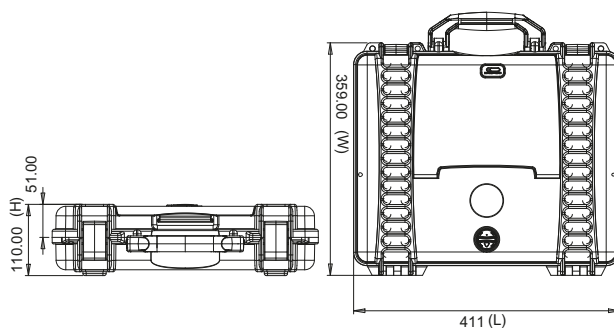

<p>* cubed foam</p>	<p>* interior bag</p>		<p>APPROVALS ATA 300 IP67 STANAG 4280 DS 81-41</p> <p>TEST DROP IMPACT HANDLE WATERTIGHT INTEGRITY UV COLOR AND MATERIAL PROTECTION</p> <p>volume in litres wheeled</p>

ACCESSORIES

<p>HPRCCF2580 CUBED FOAM USA:HPRCFO (foam only)</p>	<p>HPRCLO PADLOCK - TSA</p>	<p>HPRCSTRAP</p>	<p>HPRCORG2580 LID ORGANIZER</p>
--	--	-------------------------	---

HPRC 2600



* open cases images reflect the different HPRC cases internal options

TECHNICAL FEATURES

Dimension:
internal dimension 492x366x202(mm) - 19,37x14,41x7,95(in)
external dimension 555x432x223(mm) - 21,85x17,01x8,78(in)

lt34

lid: 47(mm) - 1,85(in) bottom: 155(mm) - 6,10(in)

Weight:
empty: 4,25kg - 9,37lbs
with cubed foam: 5,05kg - 11,13lbs

Temperature rating:
Minimum -40°C -40°F Maximum +80°C +176°F

Colors:
Black - Orange - Ferrari red - Electric blue

TECHNICAL DRAWING

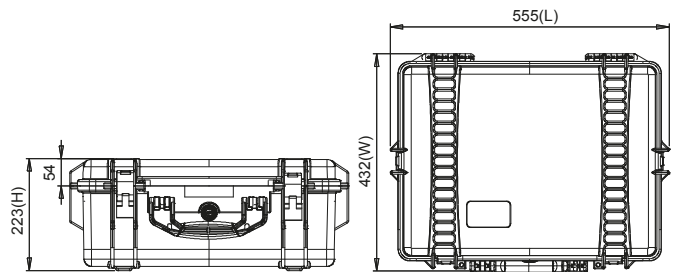

<p>* cubed foam</p>	<p>* interior bag</p>	<p>* soft padded open deck + dividers</p>	<p>APPROVALS ATA 300 IP67 STANAG 4280 DS 81-41</p> <p>TEST DROP IMPACT HANDLE WATERTIGHT INTEGRITY UV COLOR AND MATERIAL PROTECTION</p> <p>volume in litres </p>
---------------------	-----------------------	---	--

ACCESSORIES

<p>HPRCCF2600 CUBED FOAM USA:HPRCFO (foam only)</p>	<p>HPRCLO PADLOCK - TSA</p>	<p>HPRCCB2600 INTERIOR BAG USA:HPRCIC (internal case)</p>	<p>HPRCORG2600 LID ORGANIZER</p>	<p>HPRCPANELFRAME (panel not included)</p>	<p>HPRCSD2600 SOFT PADDED OPEN DECK + DIVIDERS USA: HPRCDK (divider kit)</p>
--	--	--	---	---	---

HPRC 2600W

• open cases images reflect the different HPRC cases internal options



TECHNICAL FEATURES

Dimension:
internal dimension 482x358x218(mm) - 18,98x14,09x8,58(in)
external dimension 546x423x250(mm) - 21,05x16,65x9,84(in)

lt38

lid: 46(mm) - 1,81(in) bottom: 172(mm) - 6,77(in)

W

Weight:
empty: 6,05kg - 13,34lbs
with cubed foam: 6,97kg - 15,37lbs

Temperature rating:
Minimum -40°C -40°F Maximum +80°C +176°F

Colors:
Black - Orange - Electric blue

TECHNICAL DRAWING

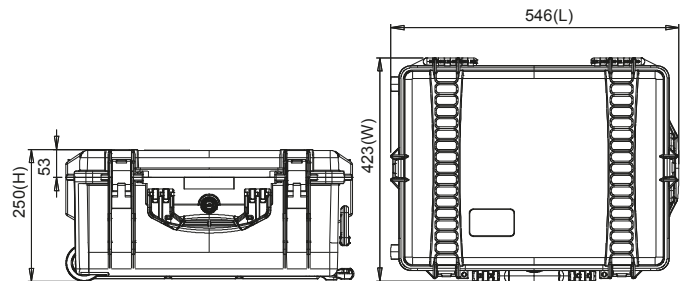

* cubed foam



* interior bag



* soft padded open deck + dividers



APPROVALS
ATA 300
IP67
STANAG 4280
DS 81-41

TEST
DROP
IMPACT
HANDLE
WATERTIGHT INTEGRITY
UV COLOR AND MATERIAL
PROTECTION

volume in litres
W

ACCESSORIES

HPRCCF2600W
CUBED FOAM
USA:HPRCFO (foam only)



HPRCLO
PADLOCK - TSA



HPRCCB2600W
INTERIOR BAG
USA:HPRCIC (internal case)



HPRCORG2600W
LID ORGANIZER



HPRCPANELFRAME
(panel not included)



HPRCSD2600W SOFT PADDED
OPEN DECK + DIVIDERS USA:
HPRCDK (divider kit)



HPRC 2700



TECHNICAL FEATURES

Dimension:
 internal dimension 555x459x205(mm) - 21,85x18,07x8,07(in)
 external dimension 617x525x227(mm) - 24,29x20,67x8,94(in)



lid: 45(mm) - 1,77(in) bottom: 160(mm) - 6,29(in)

Weight:
 empty: 5,55kg - 12,24lbs
 with cubed foam: 6,71kg - 14,79lbs

Temperature rating:
 Minimum -40°C -40°F Maximum +80°C +176°F

Colors:
 Black - Orange - Ferrari red

TECHNICAL DRAWING

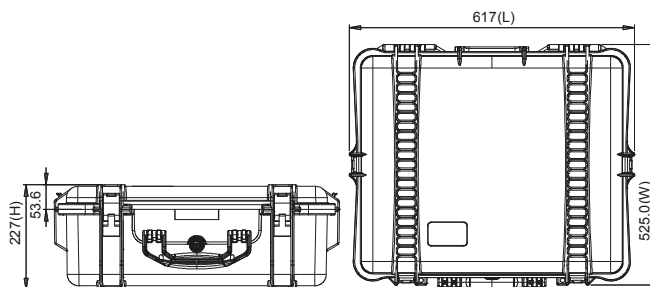

* cubed foam



* interior bag



* soft padded open deck + dividers



APPROVALS
 ATA 300
 IP67
 STANAG 4280
 DS 81-41

TEST
 DROP
 IMPACT
 HANDLE
 WATERTIGHT INTEGRITY
 UV COLOR AND MATERIAL
 PROTECTION



ACCESSORIES

HPRCCF2700
 CUBED FOAM
 USA:HPRCFO (foam only)



HPRCLO
 PADLOCK - TSA



HPRCCB2700
 INTERIOR BAG
 USA:HPRCIC (internal case)



HPRCORG2700
 LID ORGANIZER



HPRCSD2700 SOFT PADDED
 OPEN DECK + DIVIDERS USA:
 HPRCDK (divider kit)



* open cases images reflect the different HPRC cases internal options

HPRC 2700W



TECHNICAL FEATURES

Dimension:

internal dimension 555x459x256(mm) - 21,85x18,07x10,08(in)
external dimension 620x525x280(mm) - 24,41x20,67x11,02(in)

lid: 45(mm) - 1,77(in) bottom: 211(mm) - 8,30(in)

Weight:

empty: 8,30kg - 18,30lbs
with cubed foam: 9,07kg - 19,99lbs

Temperature rating:

Minimum Maximum
-40°C -40°F +80°C +176°F

Colors:

Black - Orange - Ferrari red



TECHNICAL DRAWING

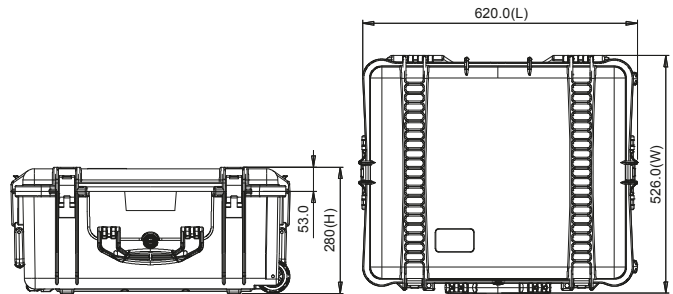

* cubed foam



* interior bag



* soft padded open deck + dividers



APPROVALS
ATA 300
IP67
STANAG 4280
DS 81-41

TEST
DROP
IMPACT
HANDLE
WATERTIGHT INTEGRITY
UV COLOR AND MATERIAL
PROTECTION



ACCESSORIES

HPRCCF2700W
CUBED FOAM
USA:HPRCFO (foam only)



HPRCLO
PADLOCK - TSA



HPRCCB2700W
INTERIOR BAG
USA:HPRCIC (internal case)



HPRCORG2700W
LID ORGANIZER



HPRCSD2700W SOFT PADDED
OPEN DECK + DIVIDERS USA:
HPRCDK (divider kit)



HPRC 2730W



TECHNICAL FEATURES

Dimension:

internal dimension 509x460x316(mm) - 20,04x18,11x12,44(in)
external dimension 620x520x350(mm) - 24,41x20,47x13,78(in)

lid: 45(mm) - 1,77(in) bottom: 271(mm) - 10,66(in)

Weight:

empty: 7,55kg - 16,64lbs
with cubed foam: 10,43kg - 22,99lbs

Temperature rating:

Minimum -40°C -40°F Maximum +80°C +176°F

Colors:

Black



TECHNICAL DRAWING

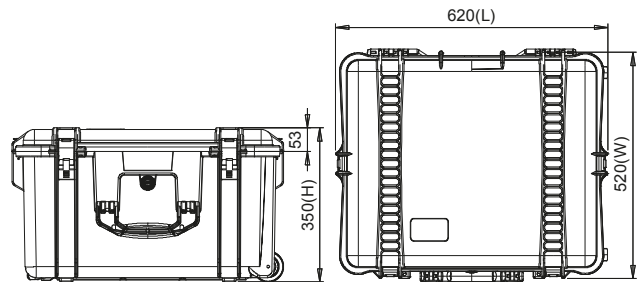

* cubed foam	* interior bag	* soft padded open deck + dividers	APPROVALS ATA 300 IP67 STANAG 4280 DS 81-41		TEST DROP IMPACT HANDLE WATERTIGHT INTEGRITY UV COLOR AND MATERIAL PROTECTION		 volume in litres

ACCESSORIES

HPRCCF2730W CUBED FOAM USA:HPRCFO (foam only)	HPRCLO PADLOCK - TSA	HPRCCB2730W INTERIOR BAG USA:HPRCIC (internal case)	HPRCORG2730W LID ORGANIZER	HPRCSD2730W SOFT PADDED OPEN DECK + DIVIDERS USA: HPRCDK (divider kit)

* open cases images reflect the different HPRC cases internal options



Discover all our products
at: www.hprc.it

HPRC 2760W



HPRC X4: When innovation becomes a case

Main features:

- 4 built in wheels: roll the case along by simply pushing it while it's on the ground
- two side handles: push or pull the case as a trolley
- stackable exterior lid design: use the case as a cart by stacking more cases on top of each other
- two lateral handles: when you need to hold the case from both sides
- comfortable soft-grip handle
- braked wheels to prevent unexpected movement

Discover more on: www.hprcx4.it

HPRC[®] X⁴
HIGH PERFORMANCE RESIN CASES



HPRC 2760W

• open cases images reflect the different HPRC cases internal options



TECHNICAL FEATURES

Dimension:

internal dimension 690x450x300(mm) - 27,16x17,71x11,81(in)
external dimension 750x510x329(mm) - 29,53x20,08x12,99(in)

lt91

lid: 50(mm) - 1,97(in) bottom: 250(mm) - 9,84(in)

W

Weight:

empty: 9,20kg - 20,28lbs
with cubed foam: 10,72kg - 23,63lbs

Temperature rating:

Minimum Maximum
-40°C -40°F +80°C +176°F

Colors:

Black

TECHNICAL DRAWING

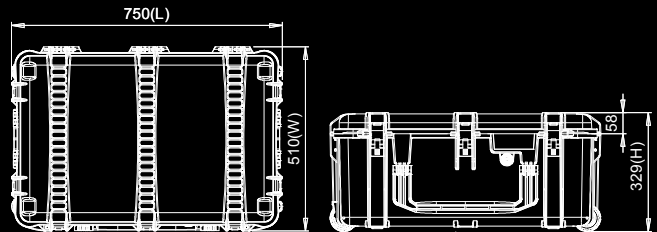

* cubed foam



* interior bag



* soft padded open deck + dividers



APPROVALS
ATA 300
IP67
STANAG 4280
DS 81-41

TEST
DROP
IMPACT
HANDLE
WATERTIGHT INTEGRITY
UV COLOR AND MATERIAL
PROTECTION

lt volume in litres

W

ACCESSORIES

HPRCCF2760W
CUBED FOAM
USA:HPRCFO (foam only)

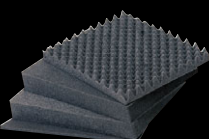

HPRCLO
PADLOCK - TSA



HPRCCB2760W
Interior bag
USA:HPRCIC (internal case)



HPRC2760W SOFT PADDED
OPEN DECK + DIVIDERS USA:
HPRCCK (divider kit)



HPRCORG2760W
LID ORGANIZER



HPRC 2780W



TECHNICAL FEATURES

Dimension:

internal dimension 749x525x366(mm) - 29,49x20,67x14,41(in)
external dimension 810x586,5x388(mm) - 31,89x23,09x15,28(in)

142

W

lid: 73(mm) - 2,87(in) bottom: 293(mm) - 11,53(in)

Weight:

empty: 12,20kg - 26,90lbs
with cubed foam: 16,18kg - 35,67lbs

Temperature rating:

Minimum -40°C -40°F Maximum +80°C +176°F

Colors:

Black

TECHNICAL DRAWING

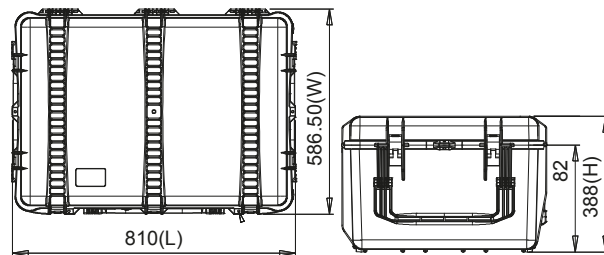

				<p>APPROVALS ATA 300 IP67 STANAG 4280 DS 81-41</p>	<p>TEST DROP IMPACT HANDLE WATERTIGHT INTEGRITY UV COLOR AND MATERIAL PROTECTION</p>
<p>* cubed foam</p>	<p>* interior bag</p>	<p>* soft padded open deck + dividers</p>	<p>volume in litres</p>	<p>Wheeled</p>	<p>Wheeled</p>

ACCESSORIES

<p>HPRCCF2780W CUBED FOAM USA:HPRCFO (foam only)</p>	<p>HPRCLO PADLOCK - TSA</p>	<p>HPRCCB2780W INTERIOR BAG USA:HPRCIC (internal case)</p>	<p>HPRCORG2780W LID ORGANIZER</p>	<p>HPRCSD2780W SOFT PADDED OPEN DECK + DIVIDERS USA: HPRCDK (divider kit)</p>
---	--	---	--	--

* open cases images reflect the different HPRC cases internal options

HPRC 2800W

* open cases images reflect the different HPRC cases internal options



TECHNICAL FEATURES

Dimension:

internal dimension 749x525x455(mm) - 29,49x20,67x17,91(in)
external dimension 810x586,5x479(mm) - 31,89x23,09x18,86(in)

lid: 73(mm) - 2,87(in) bottom: 382(mm) - 15,03(in)

Weight:

empty: 13,20kg - 29,10lbs
with cubed foam: 17,43kg - 38,43lbs

Temperature rating:

Minimum -40°C -40°F Maximum +80°C +176°F

Colors:

Black



TECHNICAL DRAWING

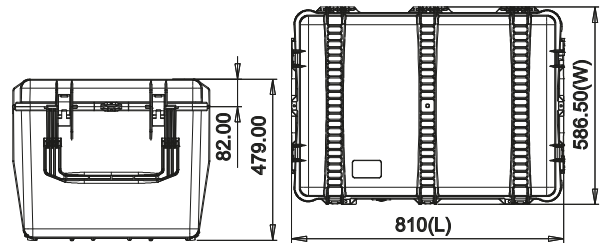

* cubed foam



* interior bag



APPROVALS
ATA 300
IP67
STANAG 4280
DS 81-41

TEST
DROP
IMPACT
HANDLE
WATERTIGHT INTEGRITY
UV COLOR AND MATERIAL
PROTECTION



ACCESSORIES

HPRCCF2800W
CUBED FOAM
USA:HPRCFO (foam only)



HPRCLO
PADLOCK - TSA



HPRCCB2800W
INTERIOR BAG
USA:HPRCIC (internal case)



HPRCORG2800W
LID ORGANIZER



HPRC 3500



TECHNICAL FEATURES

Dimension:

internal dimension 433x319x169(mm) - 17,05x12,56x6,65(in)
external dimension 498x370x185(mm) - 19,61x14,57x7,28(in)



lid: 72(mm) - 2,83(in) bottom: 97(mm) - 3,81(in)

Weight:

empty: 3,00kg - 6,61lbs
with cubed foam: 3,55kg - 7,82lbs

Temperature rating:

Minimum Maximum
-40°C -40°F +80°C +176°F

Colors:

Black

TECHNICAL DRAWING

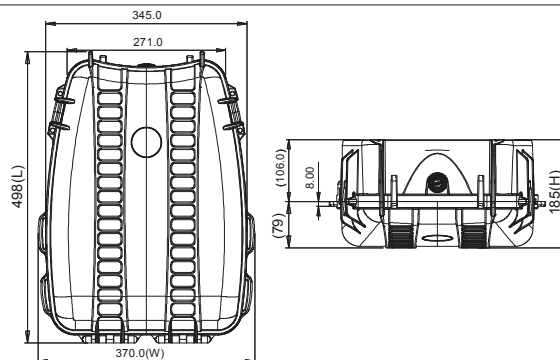

<p>* cubed foam</p>	<p>* interior bag</p>	<p>APPROVALS ATA 300 IP67 STANAG 4280 DS 81-41</p> <p>TEST DROP IMPACT HANDLE WATERTIGHT INTEGRITY UV COLOR AND MATERIAL PROTECTION</p>	

ACCESSORIES

<p>HPRCCF3500 CUBED FOAM USA:HPRCFO (foam only)</p>	<p>HPRCCB3500 INTERIOR BAG USA:HPRCIC (internal case)</p>	<p>HPRCORG3500 LID ORGANIZER</p>
--	--	---

* open cases images reflect the different HPRC cases internal options

Photo by Luigi Fieni



HPRC 4050



TECHNICAL FEATURES

Dimension:
 internal dimension 261x171x220(mm) - 10,28x6,73x8,66(in)
 external dimension 284x223x260(mm) - 11,18x8,78x10,24(in)

lid: 24(mm) - 0,94(in) bottom: 196(mm) - 7,71(in)

Weight:
 empty: 1,66kg - 3,66lbs
 with cubed foam: 1,85kg - 4,07lbs

Temperature rating:
 Minimum -40°C -40°F Maximum +80°C +176°F

Colors:
 Black



TECHNICAL DRAWING

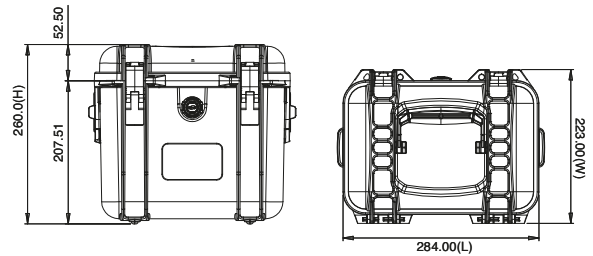

<p>* cubed foam</p>	<p>* soft padded open deck + dividers</p>	<p>APPROVALS ATA 300 IP67 STANAG 4280 DS 81-41</p>
		<p>TEST DROP IMPACT HANDLE WATERTIGHT INTEGRITY UV COLOR AND MATERIAL PROTECTION</p>

ACCESSORIES

<p>HPRCCF4050 CUBED FOAM USA:HPRCFO (foam only)</p>	<p>HPRCLO PADLOCK - TSA</p>	<p>HPRCPADDEDSTRAP</p>	<p>HPRCSD4050 SOFT PADDED OPEN DECK + DIVIDERS USA: HPRCDK (divider kit)</p>	<p>HPRCPANELFRAME SUPPORT KIT</p>	
--	---	-------------------------------	---	---	--

* open cases images reflect the different HPRC cases internal options



* open cases images reflect the different HPRC cases internal options

TECHNICAL FEATURES

Dimension:

internal dimension 401x231x231(mm) - 15,79x9,09x9,09(in)
external dimension 424x284x276,5(mm) - 16,69x11,18x10,89(in)

lid: 46(mm) - 1,81(in) bottom: 185(mm) - 7,28(in)

Weight:

empty: 2,78kg - 6,13lbs
with cubed foam: 3,27kg - 7,20lbs

Temperature rating:

Minimum -40°C -40°F Maximum +80°C +176°F

Colors:

Black



TECHNICAL DRAWING

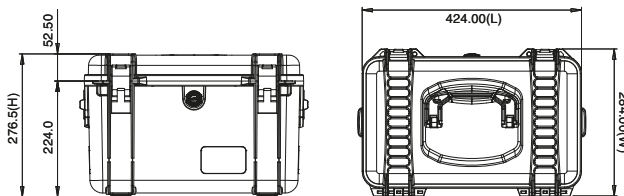

<p>* cubed foam</p>	<p>* soft padded open deck + dividers</p>	<p>APPROVALS ATA 300 IP67 STANAG 4280 DS 81-41</p> <p>TEST DROP IMPACT HANDLE WATERTIGHT INTEGRITY UV COLOR AND MATERIAL PROTECTION</p> <p>volume in litres </p>

ACCESSORIES

<p>HPRCCF4100 CUBED FOAM USA:HPRCFO (foam only)</p>	<p>HPRCLO PADLOCK - TSA</p>	<p>HPRCPADDEDSTRAP</p>	<p>HPRCSD4050 SOFT PADDED OPEN DECK + DIVIDERS USA: HPRCDK (divider kit)</p>	<p>HPRCPANELFRAME SUPPORT KIT</p>	
--	--	-------------------------------	---	--	--

HPRC 4200



TECHNICAL FEATURES

Dimension:
internal dimension 460x240x400(mm) - 18,11x9,45x15,75(in)
external dimension 483x293x445,5(mm) - 19,02x11,54x17,54(in)

lt44

lid: 66(mm) - 2,60(in) bottom: 334(mm) - 13,14(in)

Weight:
empty: 5,00kg - 11,02lbs
with cubed foam: 5,10kg - 11,24lbs

Temperature rating:
Minimum -40°C -40°F
Maximum +80°C +176°F

Colors:
Black

TECHNICAL DRAWING

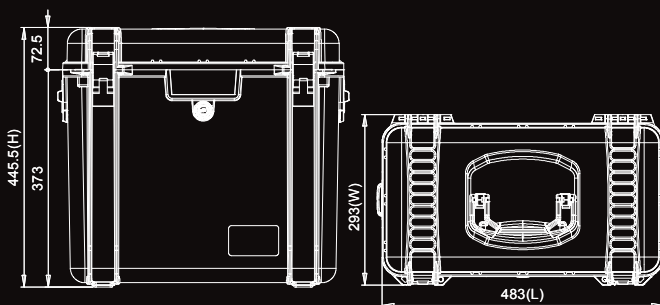

* cubed foam



* interior bag



* soft padded open deck + dividers



APPROVALS
ATA 300
IP67
STANAG 4280
DS 81-41

TEST
DROP
IMPACT
HANDLE
WATERTIGHT INTEGRITY
UV COLOR AND MATERIAL
PROTECTION



ACCESSORIES

HPRCCF4200
CUBED FOAM
USA:HPRCFO (foam only)



HPRCLO
PADLOCK - TSA



HPRCCB4200
INTERIOR BAG
USA:HPRCIC (internal case)



HPRCPADDEDSTRAP



HPRCSD4200 SOFT PADDED
OPEN DECK + DIVIDERS USA:
HPRCDK (divider kit)



HPRCPANELFRAME
SUPPORT KIT



* open cases images reflect the different HPRC cases internal options



TECHNICAL FEATURES

Dimension:

internal dimension 585x320x309(mm) - 23,03x12,60x12,17(in)
external dimension 690x380x355(mm) - 27,17x14,96x13,98(in)

lt62

lid: 80(mm) - 3,15(in) bottom: 229(mm) - 9,01(in)

Weight:

empty: 6,50kg - 14,33lbs
with cubed foam: 7,96kg - 17,54lbs

Temperature rating:

Minimum -40°C -40°F Maximum +80°C +176°F

Colors:

Black

TECHNICAL DRAWING

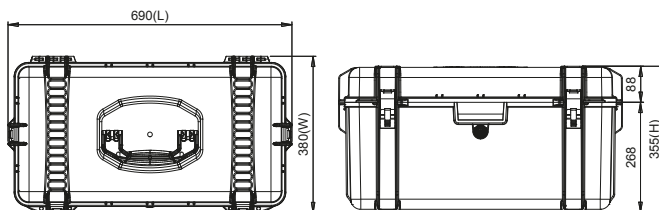

<p>* cubed foam</p>	<p>* interior bag</p>	<p>* soft padded open deck + dividers</p>	<p>APPROVALS ATA 300 IP67 STANAG 4280 DS 81-41</p> <p>TEST DROP IMPACT HANDLE WATERTIGHT INTEGRITY UV COLOR AND MATERIAL PROTECTION</p> <p>lt volume in litres wheeled</p>

ACCESSORIES

<p>HPRCCF4300 CUBED FOAM USA:HPRCFO (foam only)</p>	<p>HPRCLO PADLOCK - TSA</p>	<p>HPRCCB4300 INTERIOR BAG USA:HPRCIC (internal case)</p>	<p>HPRCSD4300 SOFT PADDED OPEN DECK + DIVIDERS USA: HPRCDK (divider kit)</p>
--	--	--	---

HPRC 4300W



TECHNICAL FEATURES

Dimension:

internal dimension 585x320x300(mm) - 23,03x12,60x11,81(in)
external dimension 690x380x358(mm) - 27,17x14,96x14,09(in)

lid: 80(mm) - 3,15(in) bottom: 220(mm) - 8,66(in)

Weight:

empty: 7,30kg - 16,09lbs
with cubed foam: 8,76kg - 19,31lbs

Temperature rating:

Minimum Maximum
-40°C -40°F +80°C +176°F

Colors:

Black



TECHNICAL DRAWING

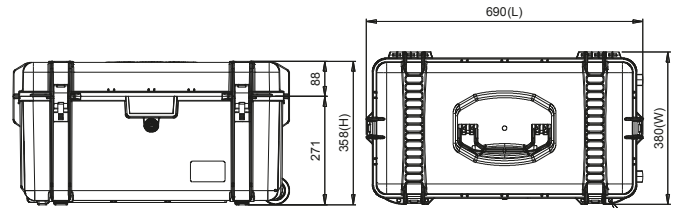

APPROVALS
ATA 300
IP67
STANAG 4280
DS 81-41

TEST
DROP
IMPACT
HANDLE
WATERTIGHT INTEGRITY
UV COLOR AND MATERIAL
PROTECTION



* cubed foam

* interior bag

* soft padded open deck + dividers

ACCESSORIES

HPRCCF4300W
CUBED FOAM
USA:HPRCFO (foam only)

HPRCLO
PADLOCK - TSA

HPRCCB4300W
INTERIOR BAG
USA:HPRCIC (internal case)

HPRCSD4300W SOFT PADDED
OPEN DECK + DIVIDERS USA:
HPRCDK (divider kit)



HPRC 4400

* open cases images reflect the different HPRC cases internal options



TECHNICAL FEATURES

Dimension:

internal dimension 420x420x389(mm) - 16,54x16,54x15,31(in)
external dimension 479x481x437(mm) - 18,86x18,94x17,20(in)

lit 74

lid: 65(mm) - 2,56(in) bottom: 324(mm) - 12,75(in)

Weight:

empty: 6,70kg - 14,77lbs
with cubed foam: 8,90kg - 19,62lbs

Temperature rating:

Minimum -40°C -40°F Maximum +80°C +176°F

Colors:

Black

TECHNICAL DRAWING

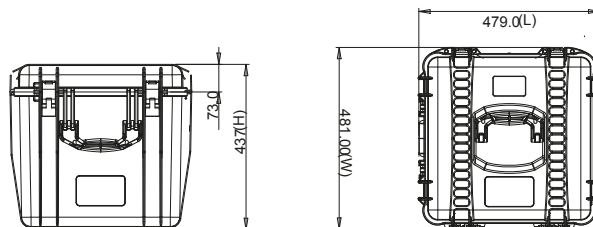

* cubed foam



APPROVALS
ATA 300
IP67
STANAG 4280
DS 81-41

TEST
DROP
IMPACT
HANDLE
WATERTIGHT INTEGRITY
UV COLOR AND MATERIAL
PROTECTION

lit volume in litres

whitelc



ACCESSORIES

HPRCCF4400
CUBED FOAM
USA:HPRCFO (foam only)



HPRCLO
PADLOCK - TSA



HPRCKITW4400
wheel kit for 4400



HPRC 4700W



TECHNICAL FEATURES

Dimension:

internal dimension 508x301x497(mm) - 20,00x11,85x19,57(in)
external dimension 572x412x564(mm) - 22,52x16,22x22,20(in)

lid: 23(mm) - 0,91(in) bottom: 474(mm) - 18,66(in)

Weight:

empty: 11,60kg - 25,57lbs
with cubed foam: 14,84kg - 32,71lbs

Temperature rating:

Minimum -40°C -40°F Maximum +80°C +176°F

Colors:

Black



TECHNICAL DRAWING

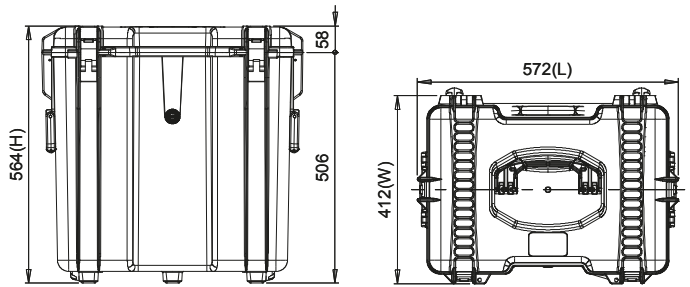

* cubed foam



* interior bag



* soft padded open deck + dividers



APPROVALS
ATA 300
IP67
STANAG 4280
DS 81-41

TEST
DROP
IMPACT
HANDLE
WATERTIGHT INTEGRITY
UV COLOR AND MATERIAL
PROTECTION



ACCESSORIES

HPRCCF4700W
CUBED FOAM
USA:HPRCFO (foam only)



HPRCLO
PADLOCK - TSA



HPRCCB4700W
Interior bag
USA:HPRCIC (internal case)



HPRCSD4700W SOFT PADDED
OPEN DECK + DIVIDERS USA:
HPRCDK (divider kit)



* open cases images reflect the different HPRC cases internal options

* open cases images reflect the different HPRC cases internal options

HPRC 5400W



TECHNICAL FEATURES

Dimension:

internal dimension 1140x350x160(mm) - 44,88x13,78x6,30(in)
external dimension 1175x410x181(mm) - 46,26x16,14x7,13(in)

lt64

W

lid: 45(mm) - 1,77(in) bottom: 115(mm) - 4,52(in)

Weight:

empty: 7,90kg - 17,42lbs
with cubed foam: 8,80kg - 19,40lbs

Temperature rating:

Minimum Maximum
-40°C -40°F +80°C +176°F

Colors:

Black

TECHNICAL DRAWING

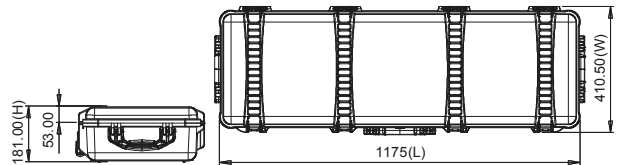

APPROVALS
ATA 300
IP67
STANAG 4280
DS 81-41

TEST
DROP
IMPACT
HANDLE
WATERTIGHT INTEGRITY
UV COLOR AND MATERIAL
PROTECTION

volume in litres
lt64
wheeled

* cubed foam

* interior bag

ACCESSORIES

HPRCCF5400W
CUBED FOAM
USA:HPRCFO (foam only)



HPRCLO
PADLOCK - TSA



HPRCCB5400W
INTERIOR BAG
USA:HPRCIC (internal case)



HPRC 6200



TECHNICAL FEATURES

Dimension:

internal dimension 651x279x243(mm) - 25,63x10,98x9,57(in)
external dimension 700x335x292(mm) - 27,56x13,19x11,50(in)

lt38

lid: 112(mm) - 4,41(in) bottom: 131(mm) - 5,15(in)

Weight:

empty: 4,00kg - 8,82lbs
with cubed foam: 5,80kg - 12,78lbs

Temperature rating:

Minimum Maximum
-40°C -40°F +80°C +176°F

Colors:

Black

TECHNICAL DRAWING

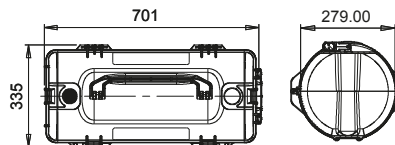

* cubed foam



* tri version



APPROVALS
ATA 300
IP67
STANAG 4280
DS 81-41

TEST
DROP
IMPACT
HANDLE
WATERTIGHT INTEGRITY
UV COLOR AND MATERIAL
PROTECTION



ACCESSORIES

HPRCCF6200
CUBED FOAM
USA:HPRCFO (foam only)



HPRC6200TRI
for tripods



HPRCLO
PADLOCK - TSA



HPRC 6300W

* open cases images reflect the different HPRC cases internal options



TECHNICAL FEATURES

Dimension:

internal dimension 921x279x243(mm) - 36,26x10,98x9,57(in)
external dimension 970x335x285(mm) - 38,19x13,19x11,22(in)

lit 54

lid: 112(mm) - 4,41(in) bottom: 131(mm) - 5,15(in)

W

Weight:

empty: 5,70kg - 12,57lbs
with cubed foam: 6,95kg - 15,32lbs

Temperature rating:

Minimum Maximum
-40°C -40°F +80°C +176°F

Colors:

Black

TECHNICAL DRAWING

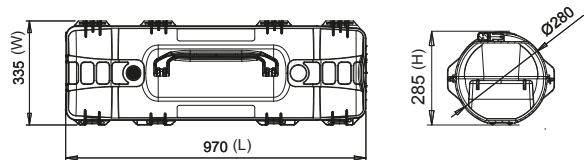

* cubed foam



* tri version



APPROVALS

ATA 300
IP67
STANAG 4280
DS 81-41

TEST

DROP
IMPACT
HANDLE
WATERTIGHT INTEGRITY
UV COLOR AND MATERIAL
PROTECTION

lit volume in litres
W wheeled

ACCESSORIES

HPRCCF6300W
CUBED FOAM
USA:HPRCFO (foam only)



HPRC6300WTRI
for tripods



HPRCLO
PADLOCK - TSA



HPRC 6400W



* tripod not included

* open cases images reflect the different HPRC cases internal options

TECHNICAL FEATURES

Dimension:

internal dimension 1081x279x243(mm) - 42,56x10,98x9,57(in)
external dimension 1128x335x258(mm) - 44,41x13,19x11,22(in)

lid: 112(mm) - 4,41(in) bottom: 131(mm) - 5,15(in)

Weight:

empty: 6,30kg - 13,89lbs
with cubed foam: 7,84kg - 17,28lbs

Temperature rating:

Minimum -40°C -40°F Maximum +80°C +176°F

Colors:

Black



TECHNICAL DRAWING

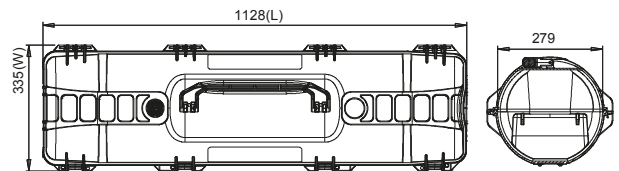

* cubed foam



* tri version



APPROVALS

ATA 300
IP67
STANAG 4280
DS 81-41

TEST

DROP
IMPACT
HANDLE
WATERTIGHT INTEGRITY
UV COLOR AND MATERIAL
PROTECTION



ACCESSORIES

HPRCCF6400W
CUBED FOAM
USA:HPRCFO (foam only)



HPRC6400WTRI
for tripods



HPRCLO
PADLOCK - TSA



HPRC 6500W

* open cases images reflect the different HPRC cases internal options



TECHNICAL FEATURES

Dimension:

internal dimension 1281x279x243(mm) - 50,43x10,98x9,57(in)
external dimension 1330x335x285(mm) - 52,36x13,19x11,22(in)

lid: 112(mm) - 4,41(in) bottom: 131(mm) - 5,15(in)

Weight:

empty: 7,20kg - 15,87lbs
with cubed foam: 9,03kg - 19,90lbs

Temperature rating:

Minimum Maximum
-40°C -40°F +80°C +176°F

Colors:

Black



TECHNICAL DRAWING

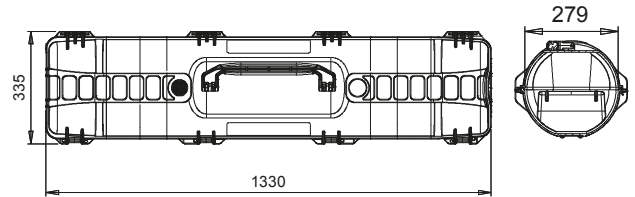

* cubed foam



* tri version



APPROVALS

ATA 300
IP67
STANAG 4280
DS 81-41

TEST

DROP
IMPACT
HANDLE
WATERTIGHT INTEGRITY
UV COLOR AND MATERIAL
PROTECTION



ACCESSORIES

HPRCCF6500W
CUBED FOAM
USA:HPRCFO (foam only)



HPRC6500WTRI
for tripods



HPRCLO
PADLOCK - TSA





Photo by Pihl Antez



Photo by Flavio Oliva



Photo by Davide Marcesini



Photo by Martin Edström



TECHNICAL FEATURES

Dimension:

closed 394x280x27,5(mm) - 15,51x11,02x1,08(in)
open 464x350x27,5(mm) - 12,26x13,77x1,08(in)

Weight:

empty: 0,95kg - 2,09lbs

Temperature rating:

Minimum Maximum
-40°C -40°F +80°C +176°F

Colors:

Black

TECHNICAL DRAWING

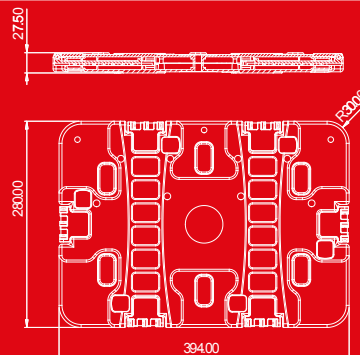

* tripod, laptop and scheller not included



APPROVALS

ATA 300
IP67
STANAG 4280
DS 81-41

TEST

DROP
IMPACT
HANDLE
WATERTIGHT INTEGRITY
UV COLOR AND MATERIAL
PROTECTION



technical chart

HPRC1100



internal dimension
57x58x25,5(mm)
2,24x2,28x1,00(in)



external dimension
69x80x32(mm)
2,72x3,15x1,26(in)

weight empty
empty: 0,04kg - 0,09lbs

Colors
Black - Ferrari red

HPRC1300



internal dimension
116x67x25,5(mm)
4,57x2,64x1,00(in)



external dimension
127x90x32(mm)
5,00x3,54x1,26(in)

weight empty
empty: 0,09kg - 0,19lbs

Colors
Black - Ferrari red

HPRC2100



internal dimension
210x145x94(mm)
8,27x5,71x3,70(in)



external dimension
235x196x110(mm)
9,25x7,72x4,33(in)

weight empty
empty: 0,76kg - 1,68lbs

Colors
Black - Orange - Ferrari red -
Electric blue

HPRC2200



internal dimension
236x182x108(mm)
9,29x7,17x4,25(in)



external dimension
258x230x123(mm)
10,16x9,06x4,84(in)

weight empty
empty: 0,87kg - 1,92lbs

Colors
Black

HPRC2250



internal dimension
236x182x155(mm)
9,29x7,17x6,10(in)



external dimension
258x230x170(mm)
10,16x9,06x6,69(in)

weight empty
1,00kg - 2,20lbs

Colors
Black

HPRC2300



internal dimension
304x231x137(mm)
11,97x9,09x5,39(in)



external dimension
335x289x155(mm)
13,19x11,38x6,10(in)

weight empty
1,67kg - 3,68lbs

Colors
Black - Orange - Ferrari red -
Electric blue

HPRC2400



internal dimension
380x266x152(mm)
14,96x10,47x5,98(in)



external dimension
405x330x170(mm)
15,94x12,99x6,69(in)

weight empty
2,05kg - 4,52lbs



Colors
Black - Orange - Ferrari red -
Electric blue

HPRC2460



internal dimension
409x306x175(mm)
16,10x12,05x6,89(in)



external dimension
434x371x193(mm)
17,09x14,61x7,60(in)

weight empty
2,60kg - 5,73lbs

Colors
Black

HPRC2500



internal dimension
450x323x175(mm)
17,72x12,72x6,89(in)



external dimension
478x390x194(mm)
18,82x15,35x7,64(in)

weight empty
3,15kg - 6,94lbs



Colors
Black - Orange - Ferrari red -
Electric blue

HPRC2530



internal dimension
513x288x132(mm)
20,20x11,34x5,20(in)



external dimension
540x350x135(mm)
21,26x13,78x5,31(in)

weight empty
3,20kg - 7,05lbs

Colors
Black

HPRC2550W



internal dimension
510x285x208(mm)
20,08x11,22x8,19(in)



external dimension
559x350x233(mm)
22,01x13,78x9,17(in)

weight empty
4,85kg - 10,69lbs



Colors
Black - Orange - Ferrari red -
Electric blue

HPRC2580



internal dimension
390x310x89(mm)
15,35x12,20x3,50(in)



external dimension
410x359x110(mm)
16,14x14,13x4,33(in)

weight empty
2,40kg - 5,29lbs

Colors
Black

HPRC2600



internal dimension
492x366x202(mm)
19,37x14,41x7,95(in)



external dimension
555x432x223(mm)
21,85x17,01x8,78(in)

weight empty
4,25kg - 9,37lbs

Colors
Black - Orange - Ferrari red -
Electric blue

HPRC2600W



internal dimension
482x358x218(mm)
18,98x14,09x8,58(in)



external dimension
546x423x250(mm)
21,05x16,65x9,84(in)

weight empty
6,05kg - 13,34lbs

Colors
Black - Orange - Electric blue

HPRC2700



internal dimension
555x459x205(mm)
21,85x18,07x8,07(in)



external dimension
617x525x227(mm)
24,29x20,67x8,94(in)

weight empty
5,55kg - 12,24lbs

Colors
Black - Orange - Ferrari red

HPRC2700W



internal dimension
555x459x256(mm)
21,85x18,07x10,08(in)



external dimension
620x525x280(mm)
24,41x20,67x11,02(in)

weight empty
8,30kg - 18,30lbs

Colors
Black - Orange - Ferrari red

HPRC2730W



internal dimension
509x460x316(mm)
20,04x18,11x12,44(in)



external dimension
620x520x350(mm)
24,41x20,47x13,78(in)

weight empty
7,55kg - 16,64lbs

Colors
Black

HPRC2760W



internal dimension
690x450x300(mm)
27,16x17,71x11,81(in)



external dimension
750x510x329(mm)
29,53x20,08x12,99(in)

weight empty
9,20kg - 20,28lbs

Colors
Black

HPRC2780W



internal dimension
749x525x366(mm)
29,49x20,67x14,41(in)



external dimension
810x586,5x388(mm)
31,89x23,09x15,28(in)

weight empty
12,20kg - 26,90lbs

Colors
Black

HPRC2800W



internal dimension
749x525x455(mm)
29,49x20,67x17,91(in)



external dimension
810x586,5x479(mm)
31,89x23,09x18,86(in)

weight empty
13,20kg - 29,10lbs

Colors
Black

HPRC3500



internal dimension
433x319x169(mm)
17,05x12,56x6,65(in)



external dimension
498x370x185(mm)
19,61x14,57x7,28(in)

weight empty
3,00kg - 6,61lbs

Colors
Black

HPRC4050



internal dimension
261x171x220(mm)
10,28x6,73x8,66(in)



external dimension
284x223x260(mm)
11,18x8,78x10,24(in)

weight empty
3,00kg - 6,61lbs

Colors
Black



HPRC4100



internal dimension
401x231x231(mm)
15,79x9,09x9,09(in)



external dimension
424x284x276,5(mm)
16,69x11,18x10,89(in)

weight empty
2,78kg - 6,13lbs

Colors
Black



HPRC4200



internal dimension
460x240x400(mm)
18,11x9,45x15,75(in)



external dimension
483x293x445,5(mm)
19,02x11,54x17,54(in)

weight empty
5,35kg - 11,79lbs

Colors
Black

technical chart

HPRC4300



internal dimension
585x320x309(mm)
23,03x12,60x12,17(in)



external dimension
690x380x355(mm)
27,17x14,96x13,98(in)

weight empty
6,50kg - 14,33lbs

Colors
Black

HPRC4300W



internal dimension
585x320x300(mm)
23,03x12,60x11,81(in)



external dimension
690x380x358(mm)
27,17x14,96x14,09(in)

weight empty
7,30kg - 16,09lbs



Colors
Black

HPRC4400



internal dimension
420x420x389(mm)
16,54x16,54x15,31(in)



external dimension
479x481x437(mm)
18,86x18,94x17,20(in)

weight empty
6,70kg - 14,77lbs

Colors
Black

HPRC4700W



internal dimension
508x301x497(mm)
20,00x11,85x19,57(in)



external dimension
572x412x564(mm)
22,52x16,22x22,20(in)

weight empty
11,60kg - 25,57lbs



Colors
Black

HPRC5400W



internal dimension
1140x350x160(mm)
44,88x13,78x6,30(in)



external dimension
1175x410x181(mm)
46,26x16,14x7,13(in)

weight empty
7,90kg - 17,42lbs



Colors
Black

HPRC6200



internal dimension
651x279x243(mm)
25,63x10,98x9,57(in)



external dimension
700x335x292(mm)
27,56x13,19x11,50(in)

weight empty
4,00kg - 8,82lbs

Colors
Black

HPRC6300W



internal dimension
921x279x243(mm)
36,26x10,98x9,57(in)



external dimension
970x335x285(mm)
38,19x13,19x11,22(in)

weight empty
5,70kg - 12,57lbs



Colors
Black

HPRC6400W



internal dimension
1081x279x243(mm)
42,56x10,98x9,57(in)



external dimension
1128x335x258(mm)
44,41x13,19x11,22(in)

weight empty
6,30kg - 13,89lbs



Colors
Black

HPRC6500W



internal dimension
1281x279x243(mm)
50,43x10,98x9,57(in)



external dimension
1330x335x285(mm)
52,36x13,19x11,22(in)

weight empty
7,20kg - 15,87lbs



Colors
Black

HPRC0500



dimension closed
394x280x27,5(mm)
15,51x11,02x1,08(in)

dimension open
464x350x27,5(mm)
12,26x13,77x1,08(in)

weight empty
empty: 0,95kg - 2,09lbs

Colors
Black

Plaber S.r.l reserves the right to modify its products at any time and without notice, in order to better their quality and functionality. Therefore, all the information given in this datasheet is to be considered indicative and subject to possible modifications.

H P R C C A S E S
MADE IN ITALY
M A N U F A C T U R E D

 Find us
on Facebook

 PlaberItalia
Channel



Plaber s.r.l. - HPRC cases

Via Div Tridentina, 10
I-36061 Bassano del Grappa
Vicenza - Italy

Tel +39 0424 809150
Fax +39 0424 808548

USA office and warehouse:

HPRC USA
240 Anderson Avenue
07074 Moonachie - New Jersey

Tel +1 201 617 2010
Fax +1 201 617 2001

www.hprc.it
E: info@hprc.it

HPRC® Brand owned by:

plaber
ITALIA