

# Lowel Tota-light Instructions

## General Warnings

The Lowel Tota-light® is a professional lighting fixture. Read these instructions and lamp manufacturer's warnings before operating.

- **Not for household use,** use only for film, video or imaging purposes.
- **Do not leave lit fixture unattended.**
- **Unplug lights when unattended** or when relamping.
- **Make certain that lamp voltage matches power source voltage.** The units use lamps of different voltages (example: never connect a 120 volt lamp to a 220/240 volt source).
- **Units such as this emit considerable light and heat** and, if not properly used, could be dangerous.
- **The Protective Screen must be used** to protect people and property in the unlikely event of a defective lamp exploding, which can cause small fragments of hot glass & filament to be scattered about.

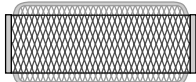

■ **Tota-light should never be operated with doors either closed or beyond the below shown "safety stop" position.**



■ **Open faced lights should not be** positioned extremely close to people. Ultraviolet light ray emissions can cause damage to the eyes and reddening of the skin. The likelihood of either occurring is increased with length of exposure, focus intensity and proximity. As a result, lights should be kept away from people. Bounce illumination also eliminates this problem.

■ **Avoid aiming the light at,** or placing close to, people, delicate objects or flammable materials.

- **Do not interfere with ventilation** by covering the lights in any way.
- **Never touch hot parts.**
- **Do not use near standing water.**
- **Lights should be operated with lamp filament horizontal.**

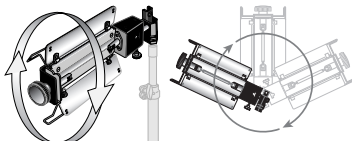

■ **Avoid mounting lights directly** over people unless secured with a safety cord or cable.



## Technical Data

**Size closed:** 2" x 3" x 11"  
(5 x 7.6 x 27.9 cm)  
**Weight less cable:** 1.3 lbs (595 g)  
**With 16' cable:** 2.25 lbs (1.02 kg)  
**Max. wattage:** 750w at 120v,  
800w at 220/240v  
**Max. amperage:** 6.25 at 120v  
**Beam control:** door angle provides vertical beam control  
**Fits on:** studs 5/8" (1.59 cm) or smaller  
**Materials:** primarily aluminum alloy  
**Cable:** 16' (4.88 m) #18/3 wire  
**Switch:** in-line  
**U.S. Patent:** 3852582

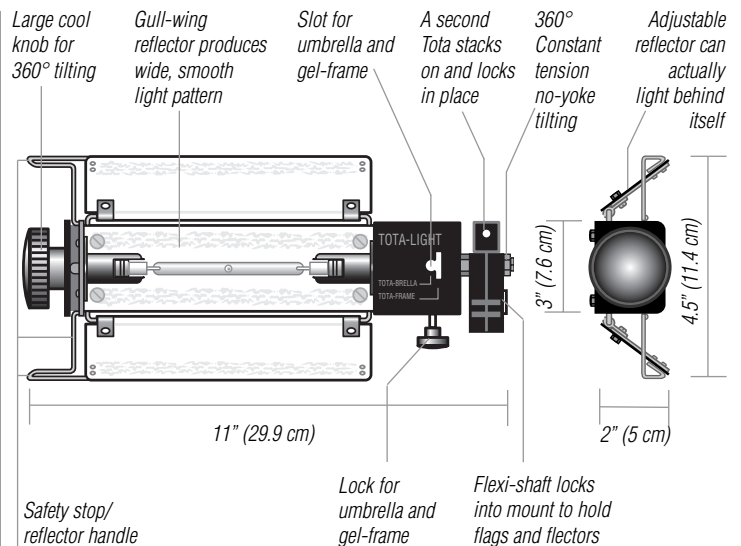

Lowel Code	Volts	Watts	°K	Avg Life	Lamp/Beam Data	
					F. C. at 10' (3 m)	
					doors norm	doors 180°
EZH	120	300	2900	2000 hr	14 (149)	11 (122)
FDN	120	500	3200	400 hr	27 (295)	22 (235)
FCZ	120	500	3000	2600 hr	26 (280)	19 (200)
FCM/HIR* (FWM)	120	650	3200	400 hr	60 (640)	45 (485)
EMD	120	750	3200	400 hr	41 (445)	34 (365)
EMF	220/240	800	3200	250 hr	45 (480)	34 (365)

- 750W max @ 120V.
- 800W max @ 220/240V.
- Tota and V-light lamps are not interchangeable.

- Tota lamps are frosted except FCM/HIR
- \*G.E. Watt Miser™, also known as FWM, has virtually same output as 1000W lamp (see manufacturers specifications).

## Tota Lamps Replacement

**Warning: Always unplug unit before relamping.**

■ Lamps must be operated at their rated voltage. Avoid touching "glass" with bare fingers, use tissue or handkerchief. Skin oil on lamp glass will focus heat unevenly and cause premature lamp failure.

■ Insert lamp carefully, to avoid breaking porcelain ends.

■ The tension springs of the Tota sockets **A** are very stiff, remove and install lamps carefully with 2 hands to avoid damaging lamp. The porcelain contact of the socket may occasionally stick in its protective metal housing. The contact can be freed by pushing against it with a pencil or other suitable object.

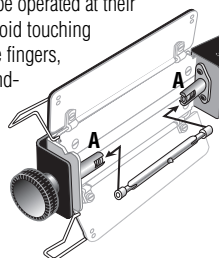

■ Due to inconsistencies in lamp (bulb) production, an individual lamp may function for less than avg. rated life. Some lamp manufacturers are of better quality than others and may provide longer life and better performance. **See Lowel Catalog or www.lowel.com for complete technical data.**

## Attaching Tota Protective Screen

**Warning: Never operate light without supplied Protective Screen.**

After opening Tota-light reflector doors, push long open edges of screen into slots between open doors of Tota-light. When storing the screen protect from bending which will effect the proper fit.

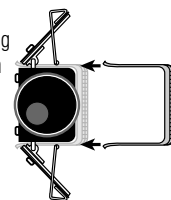

## Performance

With 120v, 750w, 3200°K, EMD lamp

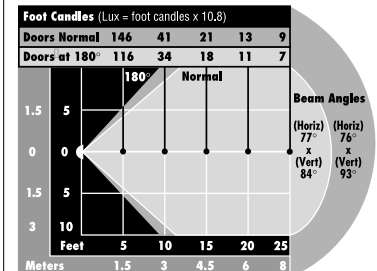

Beam angles-points at which intensity drops to 50% of maximum

## Tota Operations

### Tota Door Operating Positions

**Tota-light must be operated with doors open.**

Operating fixture with doors closed or partially closed will cause serious damage to the fixture and possible personal hazard.

**A** Maximum light intensity (total door angle of 90°). Door handles will help prevent doors from closing beyond the safe operating position.

**B** Maximum vertical spread.

**C** Compensates for light fall-off when illuminating a wall or cyc from below (opposite door configuration when lighting from above).

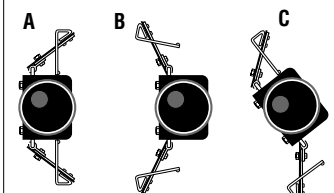

# Lowel Tota-light Instructions

## Storing Tota

### To Store Tota

When fixture is cool to the touch, disconnect plug on rear of Tota-light. Remove Protective Screen, spring out door handles slightly until open end can slip between double walls and close doors. Store Protective Screen "over" folded light. When storing the screen, protect from bending which will effect the proper fit.

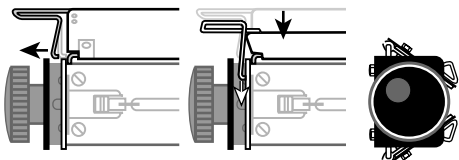
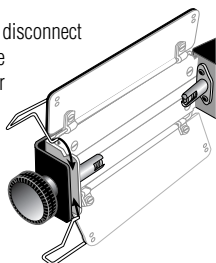

## Tota Light Controls

### Tota-shade Codes: T1-21 (1) T1-24 (set of 4)

#### Top/ Bottom Shades.

Attach Tota-shade panel to the top or bottom reflector door with black clips facing in to lock over the door's ribs.

**Side Shades** can be used only when top and bottom panels are attached. Turn each black clip 45° and attach one each to the bent rod ends of the top and bottom panels. Reflector doors must be held tightly against their 45° angle stops while doing this.

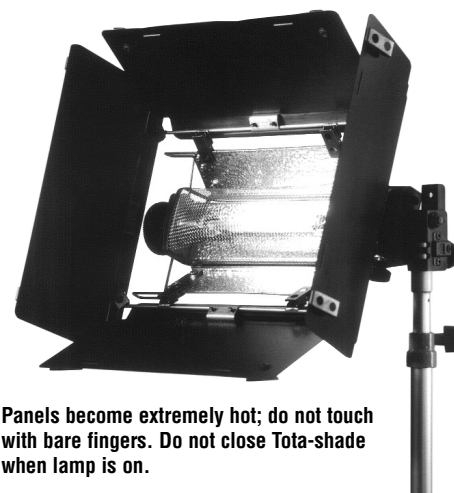
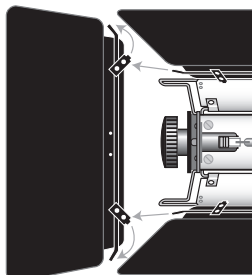

**Panels become extremely hot; do not touch with bare fingers. Do not close Tota-shade when lamp is on.**

## Tota/Omni Shared Light Control Accessories

The following components are shared by both the Tota and Omni-lights. Their attachment may differ slightly between Tota and Omni, as described below.

### Umbrellas

Photographic umbrellas convert relatively hard light sources, such as spotlights, into relatively soft sources that provide soft shadows and high-lights. Although not appropriate for every subject or mood, the quality of light can be very beautiful. There are two Umbrellas designed for use with the Tota lights, a woven, soft silver Tota-brella (T1-25) and a softer white Tota-brella (T1-26) that produces a softer light and also may be used as a large diffuser. The larger Lowel DP Umbrellas (Silver D2-25, White D2-26) may also be used with the Tota-lights (see below).

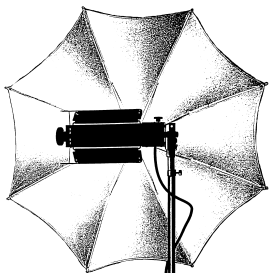

### Warning:

When lights with umbrellas are extended very high, or used on undersized stands or in areas of heavy "traffic", it is advisable to add weight (such as the Lowel weight) to the base of the stand. This reduces the chance of lights falling over which could damage the umbrella, the lamp, and possibly cause personal injury.

### Using Umbrellas with Tota

Insert umbrella through hole until shaft appears through opposite hole. Lock with knob. When the umbrella is in place, the gel frame cannot be used. Tota-shades and gels should be used for daylight correction. The use of clear instead of frosted lamps will increase the light output by approximately 15%. When using the DP Umbrella, the tilt tension of the light may have to be increased. This can be done easily by tightening the nut located on the stand fitting with a 7/16" wrench.

**Do not over tighten!**

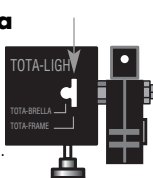

### Tota-frame

#### Code: T1-20

Unfold frame, extending frame bar and insert through front accessory mounting hole until shaft appears through opposite hole. Lock with knob.



### Tota/Omni Gels

Gels are secured to the frame with corner spring clips. Gels should not be doubled up. Precut, tough, fade resistant Lowel gels are available in daylight blue, frost diffusion, and neutral density. Gels can be cut into various shapes to cover only part of the frame and subject. (See gel instruction sheet.)

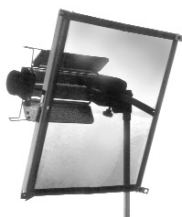

### Tota-flag & Tota-flector

#### Codes: T1-52 & T1-54

Tota flags can be used separately, or snapped together end to end or side to side. Flags can be attached to the light with a flexi-shaft. Flags block or "feather" light off background, subject, or camera lens. Tota-flectors can be attached in the same way and used to redirect some of the light. It can also provide close-up fill illumination from the sun or other source over a small area. Slight convex bowing of the surface will reduce the intensity and increase the area illumination. Avoid mounting flags or reflectors directly over people unless secured with a safety cord or cable.

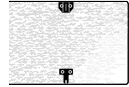
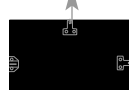

### Flexi-shaft

#### Code: T1-50 (set of 2)

A flexible arm positions Tota-flags and Tota-flectors. The fixed end of the Flexi-shaft snaps into a female connector on the Tota & Omni-lights, Tota-clamp and a few other Tota components. The rotating end snaps on to the flag, flector etc. Avoid overstressing connectors while bending and twisting. Insert the non-rotating end into the light.



### Tota-tatch

#### Code: T1-34

Spring clamp attaches Tota-flags and Tota-flectors with or without Flexi-shafts, to stands, pipes, and flat surfaces. The snap-in fitting rotates to help position flags. Tota-tatch may also be used to hold and position black & white cards, cue cards, gels, etc.

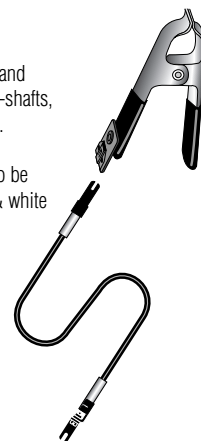

## Lampaks

Lampaks provide transparent, semi rigid foam filled storage for spare lamps. Always remove lamps from fixture & store in Lampak if the kit will be travelling for an extended period (example: flights or cargo).

**Never put hot lamps in Lampak.**



### Tota Lampak

#### Code: T1-61

Stores 6 Tota lamps in foam filled plastic case. (lamps not included)



### Tota/Omni Lampak

#### Code: TO-61

Stores 2 Tota & 4 Omni lamps in foam filled plastic case. (lamps not included)



**lowel**®

The following components are shared by both the Tota and Omni-lights.

## Omni-stand

**Code: O1-33**  
**Weight:** 2.6 lbs (1.2 kg)  
**Size:** (2.74 m), 27" (69 cm) folded  
 Sturdy and lightweight; extends to 9'. Collar clamping; standard 5/8" (1.59 cm) stud.

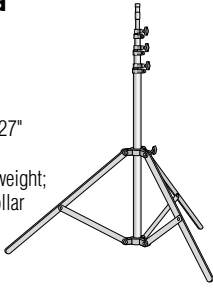

## Uni TO Stand

**Code: UN-55**  
**Weight:** 2.6 lbs (1.2 kg)  
**Size:** 21.5" (54.6 cm) folded.  
**Maximum height:** 7'11" (2.4 m)  
**Base diameter:** 43"  
 New stand, based on design combination of Uni-stand & Omni-stand. More stable than Uni-stand, more compact than Omni-stand.

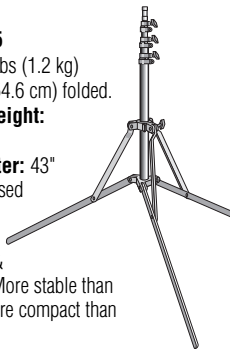

## Tota-clamp

**Code: T1-30**  
 Tota-clamp supports most lights that fit standard 5/8" studs. Tota-clamp can be attached to pipes, stands or flat surfaces. When clamping on furniture, use thin wood or cardboard to avoid marring. To rotate stud, turn wing nut counterclockwise several turns. The stud can be locked in any of four positions; two for the 5/8" stud and two for the end with the 1/4-20 tapped hole. A 1/4-20 screw can be used to lock on some microphone yokes and various accessories. Tota-clamp has two snap-in fittings for Flexi-shafts.

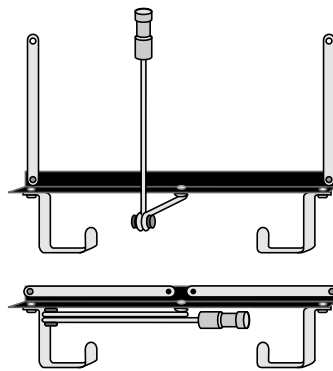

## Tota-mount

**Code: T1-32**  
 Tota-mount supports small fixtures atop doors and partitions. Doors can be open or closed. The light can be inside or outside room, since swinging arm extends past most door jams. Tota-mount can be flipped over and nailed to studio set walls or Gaffer-taped to windows or tile, wood, metal and other wall surfaces. Tota-mount should not be used with lights heavier than 3 lbs. (1.33 kg)

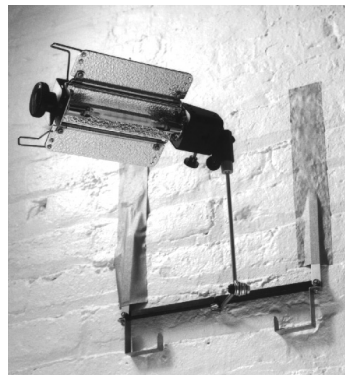

## Mounting Tota-mount with Gaffer Tape

Use 12" of Gaffer-tape on each bar of Tota-mount or side of Vipod and burnish down with a coin. Avoid wallpaper, soft composition board or flaking paint. Never attach to the ceiling with tape. Use original Lowel Gaffer-tape, as many substitutes leave adhesive residue or lack sufficient strength. When properly attached, Tota-mount or Vipod will support the light for days. However, on dirty or poorly bonded surfaces, or with improper or poorly applied tape, there is the danger of the mount falling down and causing serious damage. Check adhesion periodically. Prevent direct light from overheating tape. Remove tape when cool, by peeling back diagonally. Tota-mount should never be used with heavier lights.

## Tota/Omni Mounts

### Tota-daptor

**Code: T1-35**  
 Steps up undersize stand tops to standard 5/8". It also acts as a short extension. It has two snap-in fittings for Flexi-shafts. Two Tota-lights can be locked together by turning one of the stand fittings "backwards" and locking it onto the stand fitting extension. For each additional two Totas, a Tota-daptor must be added. The stacked lights can then be mounted on a stand or hung from a suitable clamp. Care must be exercised to provide sufficient ventilation and prevent cables from contacting lights.

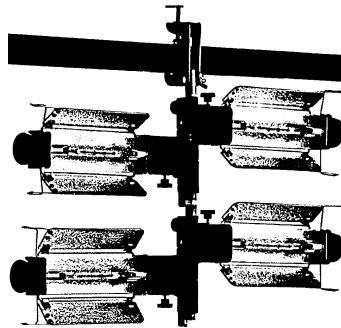
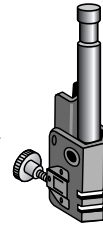

### Scissor-mount

**Code: CM-20**  
 Attaches Tota-lights, and Omni-lights to dropped ceiling: Clamp X bars of grid lock to T-Bar of ceiling frame at support cable intersection. Attach fixture to mount stud and tighten. Omni-lights should also use the Tota-daptor enabling the fixture to be turned "right side up" (top of the light facing the ceiling). Operating the Omni-lights upside down will cause short lamp life. Avoid mounting fixtures directly over people unless secured with a safety cord or cable.

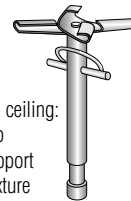

These accessories may also be used, consult their instructions for proper use.

### Space-clamp



### Grip

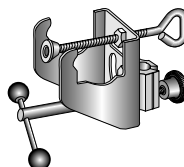

### Interlink

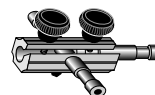

## Cables & Connectors

### 16' Tota/Omni Cable

**Code: T1-80**  
 Standard #18/3; with switch & Edison wall plug.

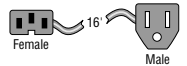

### 16' (5 m) Tota Eurocord

**Code: T1-801**  
 #18/3 (.75 mm/3) with double pole switch and male CEE-7 plug.

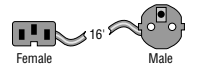

### 16' (5 m) Tota UK Cord

**Code: T1-802**  
 #18/3 (.75 mm/3) with double pole switch and male fused BS 1363A plug.

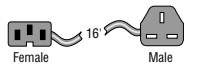

### 10' Unswitched Cable

**Code: T1-808**  
 For portable stage lighting use. "Hard service" #18/3 cable.

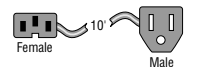

## Tota Adjustments

Tota-light has a **constant-tension tilt** (torque) which can be adjusted, if needed, by tightening the nut located on the stand fitting with a 7/16" wrench.

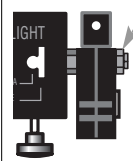

Reflector door tension can be adjusted by tightening the screws located on the rear of the reflector door with a screwdriver.

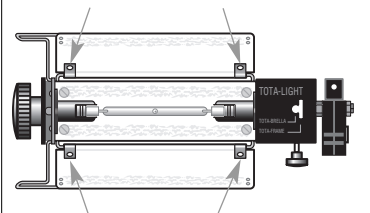

# Lowel Tota-light Instructions

## Tota for the New Pro

The wide angle coverage area of the broad throw Tota-light makes it the ideal choice for lighting a large area evenly.

The Tota-light is an open face (lensless) fixture.

Therefore its capable of throwing sharp shadows. Tota's versatility are easily extended by addition of light control accessories. For example, adding a Tota-brella instantly transforms the light into a soft Key (main) light or Fill (secondary) light.

The Tota is a tungsten-halogen source.

Its color temperature will be in the 3000–3200K° range, depending on lamp choice. To use Tota in locations where its output will mix with daylight (5600–6500K°), its color temperature can be converted by adding various strengths of day blue gels to the Tota-frame for more realistic white-balancing in video or film.

Tota is one half of the Tota/Omni lighting system.

As a starting point, when using them together in simple setups, use Omni-light **A** for focusing on your subject, and a second Omni **B** for fill if desired. Use a Tota-light **C** to illuminate your

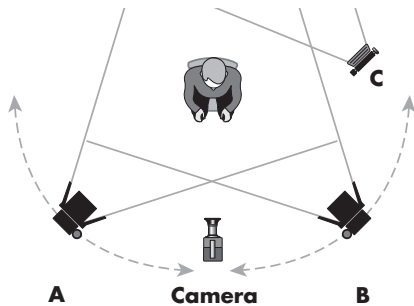

background evenly. Position of the lights and distance to the subject can be varied for different creative results.

Add diffusion gel in a Tota-frame, or attach an umbrella to create a softer source.

For soft Key & Fill in a classic interview setup, use 2 Tota's with reflective umbrellas **A & B** from 3/4 angles. Varying the distance of either light from the subject will vary the contrast ratio between Key & Fill.

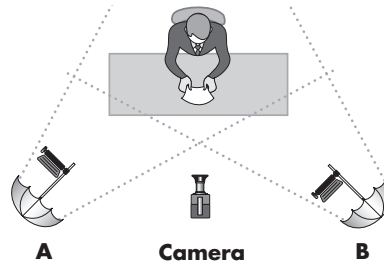

Tota's ability to light evenly makes it ideal for archival copy work. See Setup #2 below for further information.

Because the coverage area of the Tota is so wide, it may be necessary to trim its spill, especially to reduce risk of shadow in your shot caused by use of overhead boom microphones. Accessory Tota-shades attach quickly to the light & allow you to cut output on 2 or 4 sides. Flexi-shafts & Tota-flags can also be attached for increased light control options.

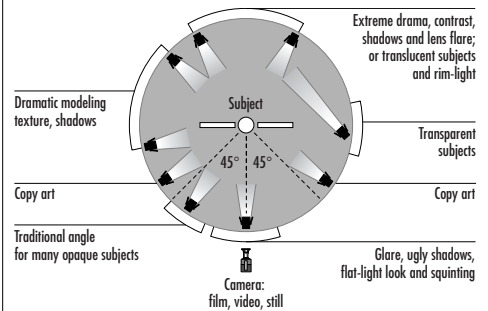

The oversimplified diagram above shows some of the ramifications of positioning lights for different subject types & lighting effects. The diagram is only useful as a starting point for new pros. All subjects & scenes are different and make different demands upon lighting. The height of the lights & camera, and the subjects angles & reflectivity must be considered.

The Tota-light can use different wattage lamps, from 300–750W at 120V. This increases its versatility, especially when mixing with other fixtures of different max. wattages. See the lamp chart for more information.

**Note:** if you need less output, it may be better to use a lower wattage lamp than to control the light with a dimmer. Dimming tungsten lamps causes their color temperature to shift warmer.

These are just some starting suggestions.

For an in-depth understanding of the creative decisions involved in the art of lighting, we suggest Ross Lowell's acclaimed book, *Matters of Light & Depth*. Available from Lowel and many of our dealers.

## Example Setups using Tota-light

### Setup #1

To simply raise the ambient level of light in a room, point the Tota-light at a white wall or ceiling (from a safe distance of several feet or more). Position the light so it won't be in your shot.

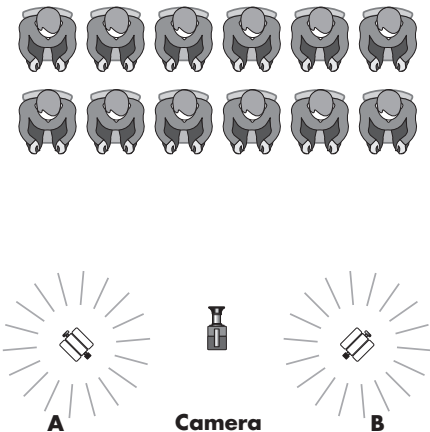

### Setup #2

For archival copy work (Example: a painting hung on a wall) start by placing Totas **A & B** on stands at 45° angles to the wall, on both sides of the camera. Vary the angle to the wall/camera to reduce unwanted reflection. Large subjects may require 2 Totas at different heights on each side.

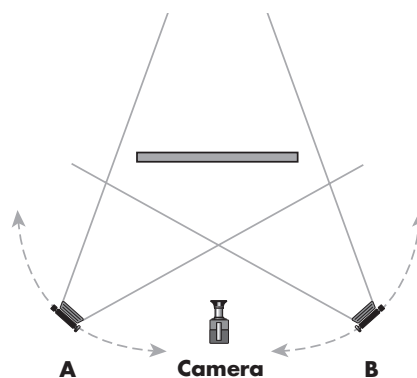

### Setup #3

In classic interview setup, use 1 Tota **A** with diffusion and Tota-frame as the key light, and another Tota **B** with reflective umbrella as the softer fill light. Vary position & angle to camera for desired creative effect. **Note:** the output of the Tota key will be harder/sharper than the Tota fill because the umbrella addition creates a softer source.

**Option:** add a third Tota **C** to evenly light the background.

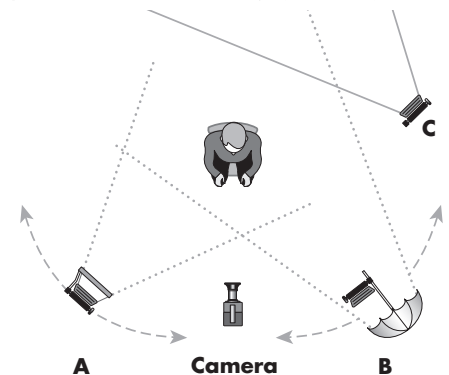

## Lowel-Light Manufacturing, Inc.



140 58th Street Brooklyn, NY 11220  
**Call:** 800 334-3426 or 718 921-0600  
**Fax:** 718 921-0303  
**e-mail:** info@lowel.com  
**www.lowel.com**

## Problems, info, repairs, etc.

Lowel equipment and kits are sold through authorized Lowel Dealers and, in some countries, Authorized Lowel Distributors. Repairs, problems, suggestions, and requests for brochures, instructions, parts lists may be handled by your authorized Lowel Dealer (Distributor) or directly with Lowel. Electrical repairs should be made only by Lowel or a qualified electrician. Lowel Omni-system, Lowel Omni-light, Lowel Tota-system and Tota-light are trademarks of Lowel-Light Manufacturing, Inc. Lowel Patent Nos.: 3852582, 4187531 version: 5.0 © Lowel-Light Mfg., Inc. 2005